

Hager Muse  
wiring accessories

# Design for comfort and safety

:hager

# Milestones of Hager wiring accessories



1919

Berker Brothers began to manufacture the first batch of rotary switches in Schalksmühle. Every detail was as simple, elegant, and functional as all Berker's other subsequent models.



1948

Traditionally, water-proof switches are made of cast resin or ceramics. Therefore, Berker's molded plastics rotary switch is a real innovation. The threads of the rotary switch are pressed into the top of the gland cover and grease cavity seals are installed on the axle. This type of switches features optimal waterproof performance. Its basic design features remained unchanged for decades of years.



1966

Although it seems quite natural today, dating back to 1966, the launch of a switch equipped with a dismantlable switch cover that can be backfilled after the completion of the painting engineering indicated a significant innovation and great progress in terms of convenience. Moreover, since the switch cover is easy to change, many of the 1966 rocker switches are still in good keep today and can still work normally.



1980

The combination of circle and square was one of our most successful products in the grim technical environment in the 1980s.



1996

'Twinpoint' design has interchangeable decorative rings, which provides all kinds of design possibilities



1928

Form + Function: When Bauhaus began to carry this concept forward, Berker Brothers have turned to the famous architect Louis Henri Sullivan's design concept. Functional and perfect design combined with reliable technology—Berker's switches already had all the elements that a product needs to become classic. These products later became classic indeed.



1957

The cover of this type of switch is as colorful as any of the modern works of art—That is why this colorful sample is called 'Chagall'.



1972

A big success, where modularization is used, the first type of stainless all-metal switch— Another real innovation.



1983

An expert to deal with difficult tasks: 'ISO-Panzer' has excellent waterproof and shockproof performances



1999

TS series can not only assist in creating special lighting effect, but can also combine KNX system for operating the complete smart home system.



2003

Full ranges included system 8000, 9000, 9088 metal ranges for Asia launched.



2008

The greatest feature of TS Crystal Ball is its glittering Swarovski crystal and sensitive optical reflection sensor, very charming.



2009

Touch of style as system 10088 equipped with large rocker and blue LED indication.



2016

Berker Q.7 not only highlights its form, functions, and craftsmanship, but also lifts architectural individuality and material application to a higher level.



2020

Hager Dream, Hager Inspire, Hager Muse with best-in-class aesthetics design, quality and full functions to answer all needs.



2004

Intelligence is a kind of beauty. Undoubtedly, B.IQ looks very beautiful: The first type of smart and fashionable home control unit in the world indicates the arrival of the new era of comfort.



2007

Only by touching... That is the artistic state to start to control a room. Technical progress makes it possible for us to combine minimalism with modern technology and create a new exchange mode.



2011

R.1 series explains its design of round angle of the excircle in its unique way. It has a soft framework outline and all kinds of functional versions. It is a good choice for all residential and decoration projects.



2013

stylea with slim and nice profile large rocker provided affordable option.



2018

Dream series, designed by the European designer, Erwin van Handenhoven, a winner of many international awards, bring elegant life experience to customers.

Extra  
comfortable





## Socket with USB charger

The socket equipped with two 2.4A USB chargers, which intelligently adapt to mobile devices with different power consumptions, ensure the charging safety and efficiency.

## Multi-gang frame

Conjoined switch combination, convenient and beautiful.

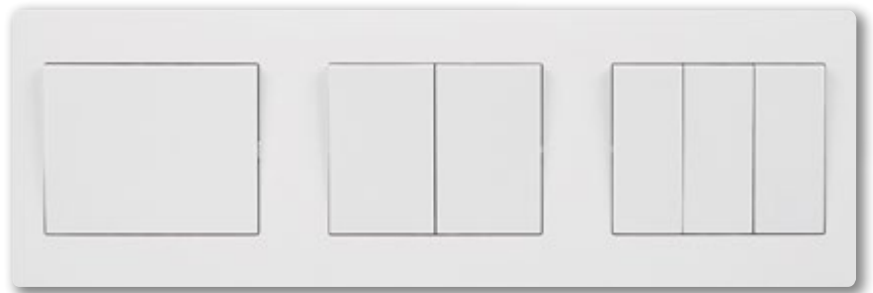

## Color options

Pursuing vibrancy and elegance with optional colors, white, aurora silver, knight black, shine the style and good taste.

# Beehive-like plate

Beehive structure, praised highly in aviation technology, has the advantages of super-strong intensity and light weight. It is used for support of the switch panel, which makes it firmer and more durable.

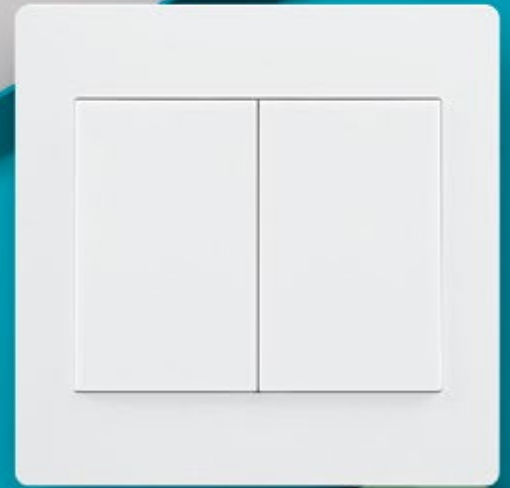



## Extra-large wiring capacity

The U-shaped screw terminal can hold three 4mm<sup>2</sup> electrical cables, making wiring work easier and faster.

## Extra-thin back mechanism

With fine craft, designed precisely, only for the purpose of providing abundant wiring space and convenient installation means.



## Terminal screws are prevented from dropping

We do everything no matter how small it is for pursuit of quality. The screw terminals are designed to provide installers with more practical use, preventing screws from dropping off during installation. We regard it as our ultimate mission to increase efficiency.

# Top-of-the-range materials

When a standard becomes well-known, Hager still walks on the highest point of the standard and uses one of the best materials in the world Bayer PC, environment friendly, anti-flaming, and strong texture.







## High 16AX rating

The rated current of switch is 16AX, which meets the requirements of using electricity safely in all aspects.

## USB protected against surge voltages

Protection against transient surge voltage for the USB circuits is provided at 2500Vac, 2.5 times higher than IEC requirement. USB output maintains at 5Vdc to ensure optimum safety for users and equipment being charged.



## Shutter

Having safety awareness all the time comes from the care for family members. The socket panel is designed with child lock, preventing unintended access by young children.

# Hager Muse series



<b>Hager Muse series</b>	<b>Page</b>
Switches	12
Dimmer and fan controller switches	13
Double pole control switches	13
Connection unit	14
15A and 16A socket outlets	14
5A and 10A socket outlets	15
13A socket outlets	15
Communication and data	16
Hotel range	17
Others	18
Product standard	19
Ingress protection	22
Circuit diagram	23
Application	26
Success cases	32

- Complies with IEC 60669-1 CB certificate

- 'AX' rated - No need to derate for fluorescent loads











- Supplied with M3.5 x 37 mm long fixing screws

- Capacity of each terminal:  
3 x 1.5 mm<sup>2</sup>  
2 X 2.5 mm<sup>2</sup>



- Two way switches can be wired either 1 way or 2 way

- Terminal markings denote:  
L1 = one way  
L2 = two way  
C = common

- Material: Polycarbonate





Description		Pack qty.	Cat. Ref. White	Cat. Ref. Aurora Silver	Cat. Ref. Knight Black
			■	■	■
		<b>Large dolly switch</b>			
WGML111	WGML121	10	<b>WGML111</b>	<b>WGML111AS</b>	<b>WGML111KB</b>
WGML112	WGML122	10	<b>WGML112</b>	<b>WGML112AS</b>	<b>WGML112KB</b>
		10	<b>WGML121</b>	<b>WGML121AS</b>	<b>WGML121KB</b>
		10	<b>WGML122</b>	<b>WGML122AS</b>	<b>WGML122KB</b>
		10	<b>WGML131</b>	<b>WGML131AS</b>	<b>WGML131KB</b>
WGML131	WGML141	10	<b>WGML132</b>	<b>WGML132AS</b>	<b>WGML132KB</b>
WGML132	WGML142	10	<b>WGML141</b>	<b>WGML141AS</b>	<b>WGML141KB</b>
		10	<b>WGML142</b>	<b>WGML142AS</b>	<b>WGML142KB</b>
		10	<b>WGML113</b>	<b>WGML113AS</b>	<b>WGML113KB</b>
WGML113	WGML111B	10	<b>WGML111B</b>	<b>WGML111BAS</b>	<b>WGML111BKB</b>
		10	<b>WGML111E</b>	<b>WGML111EAS</b>	<b>WGML111EKB</b>
WGML111E					
		<b>Press switch</b>			
WGML111P	WGML121P	10	<b>WGML111P</b>	<b>WGML111PAS</b>	<b>WGML111PKB</b>
		10	<b>WGML121P</b>	<b>WGML121PAS</b>	<b>WGML121PKB</b>
		10	<b>WGML131P</b>	<b>WGML131PAS</b>	<b>WGML131PKB</b>
		10	<b>WGML141P</b>	<b>WGML141PAS</b>	<b>WGML141PKB</b>
WGML131P	WGML141P				

- Complies with IEC 60669-2-1
- Supplied with M3.5 x 37 mm long fixing screws
- Material: Polycarbonate
- Capacity of each terminal:  
3 x 1.5 mm<sup>2</sup>

Description	Pack qty.	Cat. Ref. White	Cat. Ref. Aurora Silver	Cat. Ref. Knight Black
		■	■	■
  WGMEFR250      WGMEDR500	6	<b>WGMEFR250</b>	<b>WGMEFR250AS</b>	<b>WGMEFR250KB</b>
250VA single fan control	6			
40-500W single dimmer, 2 way	6	<b>WGMEDR500</b>	<b>WGMEDR500AS</b>	<b>WGMEDR500KB</b>

**Hager Muse**  
Double pole control switches



- Complies with IEC 60669-1 CB certificate
- Supplied with M3.5 x 37 mm long fixing screws
- Capacity of each terminal:  
**20AX**  
L, N, E: 2 x 4 mm<sup>2</sup>  
  
**32A, 45A**  
L, N : 2.5 mm<sup>2</sup> ~ 16 mm<sup>2</sup>  
E x 2 : 2.5 mm<sup>2</sup> ~ 16 mm<sup>2</sup>
- Material: Polycarbonate

Description	Pack qty.	Cat. Ref. White	Cat. Ref. Aurora Silver	Cat. Ref. Knight Black
		■	■	■
  WGML2D1      WGML2D2	10	<b>WGML2D1</b>	<b>WGML2D1AS</b>	<b>WGML2D1KB</b>
<b>DP switch</b> 20AX, 1 gang	10			
20AX, 2 gang	10	<b>WGML2D2</b>	<b>WGML2D2AS</b>	<b>WGML2D2KB</b>
20AX, 1 gang with LED	10	<b>WGML2D1N</b>	<b>WGML2D1NAS</b>	<b>WGML2D1NKB</b>
20AX, 2 gang with LED	10	<b>WGML2D2N</b>	<b>WGML2D2NAS</b>	<b>WGML2D2NKB</b>
20AX, 1 gang 2 way with LED	10	<b>WGML2D12N</b>	<b>WGML2D12NAS</b>	<b>WGML2D12NKB</b>
  WGML2D1N      WGML2D2N WGML2D12N				

Remark: Grey reference product - coming soon

Special marks	Abbreviation	Special marks	Abbreviation	Special marks	Abbreviation
"AIR CONDITONER"	AC	"HOB"	HB	"WASHER"	WS
"DISH WASHER"	DW	"HOOD"	HD	"WASHING MACHINE"	WM
"DRYER"	DR	"MICROWAVE"	MW	"WATER HEATER"	WH
"FRIDGE"	FR	"OVEN"	OV		

Example: **"WATER HEATER" WH**  
20AX 1 gang with LED      **WGML2D1NWH**   **WGML2D1NASWH**   **WGML2D1NKBWH**

  WGMR32D1      WGMR45D1	8	<b>WGMR32D1</b>	<b>WGMR32D1AS</b>	<b>WGMR32D1KB</b>
<b>Control switch with LED</b> 32A with LED	8			
45A with LED	8	<b>WGMR45D1</b>	<b>WGMR45D1AS</b>	<b>WGMR45D1KB</b>







- Complies with  
BS 5733  
IEC 60998-1  
IEC 60998-2-1  
BS 1363-4 (Fused connection units)

- Supplied with M3.5 x 37 mm  
long fixing screws

- Capacity of each terminal:  
**25A**  
L, N, E: 4 x 2.5mm<sup>2</sup> or 2 x 4mm<sup>2</sup>  
or 1 x 6mm<sup>2</sup>  
**45A**  
L, N, E: 7 x 2.5mm<sup>2</sup> or 4 x 4mm<sup>2</sup>  
or 2 x 6mm<sup>2</sup>

**13A FCU**  
L, N : 3 x 4.0 mm<sup>2</sup>  
E : 2 x 4.0 mm<sup>2</sup>

- Material: polycarbonate

Description		Pack qty.	Cat. Ref. White	Cat. Ref. Aurora Silver	Cat. Ref. Knight Black
					
WGMR25	WGMR45				
	25A with flex outlet	14	<b>WGMR25</b>	<b>WGMR25AS</b>	<b>WGMR25KB</b>
	45A with flex outlet	10	<b>WGMR45</b>	<b>WGMR45AS</b>	<b>WGMR45KB</b>
					
WGMR13	WGMR13N				
	13A fused with flex outlet	10	<b>WGMR13</b>	<b>WGMR13AS</b>	<b>WGMR13KB</b>
	13A fused with LED + flex outlet	10	<b>WGMR13N</b>	<b>WGMR13NAS</b>	<b>WGMR13NKB</b>
					
WGMR13S	WGMR13SN				
	13A switched fused with flex outlet	10	<b>WGMR13S</b>	<b>WGMR13SAS</b>	<b>WGMR13SKB</b>
	13A switched fused with flex outlet, with LED	10	<b>WGMR13SN</b>	<b>WGMR13SNAS</b>	<b>WGMR13SNKB</b>

Remark: Grey reference product - coming soon

## Hager Muse

### 15A and 16A socket outlets

- Complies with  
BS 546 (15A socket)  
SS 472 (15A socket)  
IEC 60884-1  
(German socket)  
(Euro-American socket)









- Supplied with M3.5 x 37 mm  
long fixing screws

- Capacity of each terminal:  
L, N, E : 3 X 2.5 mm<sup>2</sup> or  
2 X 4.0 mm<sup>2</sup>

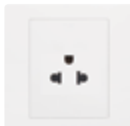
- USB output current  
2.4A (Max)

- Material: Polycarbonate

- Integral rocker design of  
switched sockets provides  
clear red 'on' indication

Description		Pack qty.	Cat. Ref. White	Cat. Ref. Aurora Silver	Cat. Ref. Knight Black
					
WGMS115S	WGMS116S				
	15A round pin switched	10	<b>WGMS115S</b>	<b>WGMS115SAS</b>	<b>WGMS115SKB</b>
	16A German with shutter	8	<b>WGMS116S</b>	<b>WGMS116SAS</b>	<b>WGMS116SKB</b>
					
WGMS116EA	WGMS216EA				
	16A single Euro-American	10	<b>WGMS116EA</b>	<b>WGMS116EAAS</b>	<b>WGMS116EAKB</b>
	16A twin Euro-American	10	<b>WGMS216EA</b>	<b>WGMS216EAAS</b>	<b>WGMS216EAKB</b>
					
WGMS116IS	WGMS216IS				
	16A single switched universal	10	<b>WGMS116IS</b>	<b>WGMS116ISAS</b>	<b>WGMS116ISKB</b>
	16A twin switched universal	12	<b>WGMS216IS</b>	<b>WGMS216ISAS</b>	<b>WGMS216ISKB</b>
					
WGMS116ISUSB	WGMS216UI				
	16A single switched universal + 2x USB chargers	8	<b>WGMS116ISUSB</b>	<b>WGMS116ISUSBAS</b>	<b>WGMS116ISUSBKB</b>
	16A, 2+3 pin universal	8	<b>WGMS216UI</b>	<b>WGMS216UIAS</b>	<b>WGMS216UIKB</b>

- Complies with  
BS 547 (5A socket)  
SS 472 (5A socket)  
IEC 60884-1 (10A socket)

- Supplied with M3.5 x 37 mm  
long fixing screws

- Capacity of each terminal:  
L, N, E : 3 X 2.5 mm<sup>2</sup> or  
2 X 4.0 mm<sup>2</sup>

- Integral rocker design of  
switched sockets provides  
clear red 'on' indication  
  
- Material: Polycarbonate



WGMS105S



WGMS110US



WGMS210U

Description	Pack qty.	Cat. Ref. White	Cat. Ref. Aurora Silver	Cat. Ref. Knight Black
<b>Socket outlet</b>				
5A, round pin switched	10	<b>WGMS105S</b>	<b>WGMS105SAS</b>	<b>WGMS105SKB</b>
10A, 2 pin switched universal	10	<b>WGMS110US</b>	<b>WGMS110USAS</b>	<b>WGMS110USKB</b>
10A, 2 pin + 2 pin universal	10	<b>WGMS210U</b>	<b>WGMS210UAS</b>	<b>WGMS210UKB</b>

Remark: Grey reference product - coming soon

## Hager Muse 13A socket outlets

- Complies with  
BS 1363-2  
SS 145-2

- Supplied with M3.5 x 37 mm  
long fixing screws

- USB output current  
2.4A (Max)

- Material: Polycarbonate

- Capacity of each terminal:  
L, N, E : 3 X 2.5 mm<sup>2</sup> or  
2 X 4.0 mm<sup>2</sup>

- Integral rocker design of  
switched sockets provides  
clear red 'on' indication



WGMS113



WGMS113S



WGMS113N



WGMS113SUSB



WGMS113S1USB



WGMS213



WGMS213S



WGMS213N



WGMS213SUSB

Description	Pack qty.	Cat. Ref. White	Cat. Ref. Aurora Silver	Cat. Ref. Knight Black
13A single	10	<b>WGMS113</b>	<b>WGMS113AS</b>	<b>WGMS113KB</b>
13A single switched	10	<b>WGMS113S</b>	<b>WGMS113SAS</b>	<b>WGMS113SKB</b>
13A single switched with LED	10	<b>WGMS113N</b>	<b>WGMS113NAS</b>	<b>WGMS113NKB</b>
13A single switched + 2 x USB charger	8	<b>WGMS113SUSB</b>	<b>WGMS113SUSBAS</b>	<b>WGMS113SUSBKB</b>
13A single switched + 1 x USB charger	8	<b>WGMS113S1USB</b>	<b>WGMS113S1USBAS</b>	<b>WGMS113S1USBKB</b>
13A twin	14	<b>WGMS213</b>	<b>WGMS213AS</b>	<b>WGMS213KB</b>
13A twin switched	14	<b>WGMS213S</b>	<b>WGMS213SAS</b>	<b>WGMS213SKB</b>
13A twin switched with LED	14	<b>WGMS213N</b>	<b>WGMS213NAS</b>	<b>WGMS213NKB</b>
13A twin switched + 2 x USB charger	10	<b>WGMS213SUSB</b>	<b>WGMS213SUSBAS</b>	<b>WGMS213SUSBKB</b>

Remark: Grey reference product - coming soon

- Supplied with M3.5 x 37 mm long fixing screws

- Material: Polycarbonate

		Description	Pack qty.	Cat. Ref. White	Cat. Ref. Aurora Silver	Cat. Ref. Knight Black
		<b>RJ11 outlet</b>				
WGMT1RJ	WGMT2RJ	1 mod	10	WGMT1RJ	WGMT1RJAS	WGMT1RJKB
		2 mod	10	WGMT2RJ	WGMT2RJAS	WGMT2RJKB
WGMT1RJ6	WGMT1RJ6NM	<b>RJ45 cat6 outlet</b>				
		1 mod	10	WGMT1RJ6	WGMT1RJ6AS	WGMT1RJ6KB
WGMT2RJ6	WGMT2RJ6NM	1 mod without symbol	10	WGMT1RJ6NM	WGMT1RJ6NMAS	WGMT1RJ6NMKB
		2 mod	10	WGMT2RJ6	WGMT2RJ6AS	WGMT2RJ6KB
WGMT1RJ5	WGMT2RJ5	2 mod without symbol	10	WGMT2RJ6NM	WGMT2RJ6NMAS	WGMT2RJ6NMKB
		<b>RJ45 cat5e outlet</b>				
WGMT2RJRJ5	WGMT2RJRJ6	1 mod	10	WGMT1RJ5	WGMT1RJ5AS	WGMT1RJ5KB
		2 mod	10	WGMT2RJ5	WGMT2RJ5AS	WGMT2RJ5KB
		<b>RJ11 + RJ45 cat5e</b>	10	WGMT2RJRJ5	WGMT2RJRJ5AS	WGMT2RJRJ5KB
WGMT1RJ6LP	WGMT1RJ6LPNM	<b>RJ11 + RJ45 cat6</b>	10	WGMT2RJRJ6	WGMT2RJRJ6AS	WGMT2RJRJ6KB
		<b>Plate for RJ45 engine</b>				
WGMT2RJ6LP	WGMT2RJ6LPNM	1 mod	20	WGMT1RJ6LP	WGMT1RJ6LPAS	WGMT1RJ6LPKB
		1 mod without symbol	20	WGMT1RJ6LPNM	WGMT1RJ6LPNMAS	WGMT1RJ6LPNMKB
		2 mod	20	WGMT2RJ6LP	WGMT2RJ6LPAS	WGMT2RJ6LPKB
WGMT2TVRJ5		2 mod without symbol	20	WGMT2RJ6LPNM	WGMT2RJ6LPNMAS	WGMT2RJ6LPNMKB
		<b>TV inlet/outlet + RJ45 cat5e</b>	10	WGMT2TVRJ5	WGMT2TVRJ5AS	WGMT2TVRJ5KB
WGMT1TV	WGMT2TVRJ6	<b>TV inlet/outlet</b>	10	WGMT1TV	WGMT1TVAS	WGMT1TVKB
		<b>TV inlet/outlet + RJ45 cat6 (DATA marking)</b>	10	WGMT2TVRJ6	WGMT2TVRJ6AS	WGMT2TVRJ6KB
WGMT1TVF	WGMT2TVFRJ6	<b>TV outlet, F type</b>	10	WGMT1TVF	WGMT1TVFAS	WGMT1TVFKB
		<b>TV outlet, F type + RJ45 Cat6 (DATA marking)</b>	10	WGMT2TVFRJ6	WGMT2TVFRJ6AS	WGMT2TVFRJ6KB
WGMTSMATV		<b>SMATV outlet</b> SAT+TV+FM	30	WGMTSMATV	WGMTSMATVAS	WGMTSMATVKB



- Complies with  
IEC 60669-1  
IEC 60669-2-1  
IEC 62368-1 (USB)

- Supplied with M3.5 x 37 mm  
long fixing screws

- Material: Polycarbonate

	Description	Pack qty.	Cat. Ref. White	Cat. Ref. Aurora Silver	Cat. Ref. Knight Black
					
 WGMHDC	16AX, DND & MUR with LED (Indoor)	10	<b>WGMHDC</b>	<b>WGMHDCAS</b>	<b>WGMHDCKB</b>
 WGMEA6	6W Audio switch	6	<b>WGMEA6</b>	<b>WGMEA6AS</b>	<b>WGMEA6KB</b>
 WGMS3USB	USB charger 4.2A (1 type C) + (2 x type A)	8	<b>WGMS3USB</b>	<b>WGMS3USBAS</b>	<b>WGMS3USBKB</b>
 WGMHKTM WGMHKTRFID	16A key tag - mechanical	6	<b>WGMHKTM</b>	<b>WGMHKTMAS</b>	<b>WGMHKTMKB</b>
	16A key tag - RFID	6	<b>WGMHKTRFID</b>	<b>WGMHKTRFIDAS</b>	<b>WGMHKTRFIDKB</b>

	Description	Pack qty.	Cat. Ref. White	Cat. Ref. Aurora Silver	Cat. Ref. Knight Black
WGMCH2	2 gang, multi-gang, horizontal	18	<b>WGMCH2</b>	<b>WGMCH2AS</b>	<b>WGMCH2KB</b>
WGMCH3	3 gang, multi-gang, horizontal	12	<b>WGMCH3</b>	<b>WGMCH3AS</b>	<b>WGMCH3KB</b>
WGMCH4	4 gang, multi-gang, horizontal	12	<b>WGMCH4</b>	<b>WGMCH4AS</b>	<b>WGMCH4KB</b>
WGMCH5	5 gang, multi-gang, horizontal	12	<b>WGMCH4</b>	<b>WGMCH4AS</b>	<b>WGMCH4KB</b>
WGMBP1	<b>Blank plate</b> 1 gang	20	<b>WGMBP1</b>	<b>WGMBP1AS</b>	<b>WGMBP1KB</b>
	Blank plate (size 2)	10	<b>WGMBP2</b>	<b>WGMBP2AS</b>	<b>WGMBP2KB</b>
	Remark: Grey reference product - coming soon				
WGMCV1	<b>Single frame</b> 1 gang frame (vertical) 52 x 65 mm	40	<b>WGMCV1</b>	<b>WGMCV1AS</b>	<b>WGMCV1KB</b>
WGMC2	2 gang frame	40	<b>WGMC2</b>	<b>WGMC2AS</b>	<b>WGMC2KB</b>
WGMC1	1 gang frame (horizontal) 65 x 52 mm	40	<b>WGMC1</b>	<b>WGMC1AS</b>	<b>WGMC1KB</b>
WGMC1S	1 gang frame (square) 52 x 52 mm	40	<b>WGMC1S</b>	<b>WGMC1SAS</b>	<b>WGMC1SKB</b>
XC9003	<b>WA covers (Transparent)</b> IP55 single size	40	<b>XC9003</b>		
XC9004	IP55 twin size	40	<b>XC9004</b>		

**Compliance with standards**

Regulation 511-01-01 of BS 7671 : Requirements for Electrical Installations, IEE Wiring Regulations Sixteenth Edition is of particular importance to specifiers and installers with respect to product standards.

Regulation 511-01-01 requires every item of equipment to comply with the relevant requirements of the applicable British Standard, or Harmonised Standard appropriate to the intended use of the equipment.

**British Standards (BS)**

The BSI (British Standards Institution) was the first national standards body in the world. There are now more than 100 similar organisations which belong to the International Organisation for Standardisation (ISO) and the International Electrotechnical Commission (IEC).

British Standards are drawn up by all those who have a particular interest in the subject i.e. manufacturers, users, research organisations, government departments and consumers. This work is co-ordinated by BSI staff, acting as secretaries to the committees where the work is done. All standards are made available for public comment before they are published.

**Harmonised standards**

A Harmonised standard is a European standard formally presented by CENELEC, to the European Commission and published in the commission's official journal. CENELEC is the Comité Européen de Normalisation Electrotechnique i.e. European Committee for Electrotechnical Standardisation.

BS 7671 part 2 defines a harmonised standard as a standard which has been drawn up by common agreement between national standards bodies notified to the European Commission by all member states and published under national procedures. The UK national standards body is the British Standards Institution. In the UK a harmonised standard will normally be published as a British Standard European Norm i.e. BS EN.

**British Standard European Norm (BS EN)**

CENELEC European standards are pre-fixed EN (European Norm). Adoption of the European Standard within the EC is mandatory and member countries of CENELEC are obliged to publish them unchanged. In the UK such standards are further endorsed with the additional prefix 'BS', for example BS EN 60669-1 : 1996 is the British Standard European Norm for Switches for household and similar fixed electrical installations.

Whilst a European Standard can be a direct replica of an IEC standard, discussions within CENELEC may result in the formulation of a standard which includes commonly agreed variations and Special National Conditions.

**International Electrotechnical Commission (IEC)**

Founded in 1906 the International Electrotechnical Commission (IEC) is the world organisation that prepares and publishes international standards for all electrical, electronic and related technologies. The membership consists of 60 participating countries, including all the world's major trading nations and a growing number of industrialising countries.

Foreign national standards based on IEC standards are permitted to be used by BS 7671. However the specifier must verify that any differences between the foreign standard and the corresponding British Standard or Harmonised Standard does not result in any lesser degree of safety than that afforded by compliance with the British Standard. This assessment would probably need to be made by specialists.

**Conclusion**

BS 7671 (IEE Wiring Regulations) recognises equipment which complies with a British Standard or Harmonised Standard appropriate to the intended use of the equipment without the need for further qualification.

Hager products have always been designed and manufactured to a high standard to ensure compliance with the current British or Harmonised Standard. See the table below for further information.

Product description	BS / IEC number	Description
Switches	BS EN 60669-1 IEC 60669-1 CB certificate	Switches for household and similar fixed electrical installations
Indicators	BS 5733	General requirements for Electrical Accessories
Fused connection unit, cord outlets	BS 5733	Switches for household and similar fixed electrical installations with particular requirements for timedelay switches (TDS)
Dimmers	BS EN 60669-2-3	Switches for household and similar fixed electrical installations with particular requirements for timedelay switches (TDS)
Frames and plates	BS 5733	Switches for household and similar fixed electrical installations with particular requirements for timedelay switches (TDS)
10 /16 Amp Wall switch	BS EN 60669-1 IEC 60669-1 CB certificate	Switches for household and similar fixed electrical installations
Dimmer switches	BS EN 60669-2-1 IEC 60669-2-1	Electronic variable control switches (dimmer switches) for tungsten filament lighting
13 Amp Socket Outlets	BS 1363- 2 SS145-2	13A plugs, socket-outlets, adaptors and connection units
15 Amp Switched Socket	BS 546 SS472 MS 1577	Specification. Two-pole and earthing-pin plugs, socket-outlets and socket-outlet adaptors
20 Amp D.P. Switches	BS EN 60669-1 IEC 60669-1 CB certificate	Switches for household and similar fixed electrical installations
13 Amp Fused Connection Unit	BS 1363-4	Specification for 13A fused connection units switched and unswitched
45 Amp D.P. Switches	BS EN 60669-1 IEC 60669-1 CB certificate	Switches for household and similar fixed electrical installations
45 Amp Cooker Control Unit	BS 4177	Cooker control units
Shaver Socket Outlet	BS EN 61558-2-5  IEC 61558-2-5	General Requirements Isolating transformers and safety isolating transformers  Electromagnetic compatibility, immunity requirements for household CB certificate appliances tools and similar apparatus.
25 Amp/ Amp Flex Outlet Plate	BS 5733	General Requirements for Electrical Accessories
BS Batten	BS EN 61184 IEC 61184 BS EN 60238 IEC 60238	Home office shield are T2 rated
Ceiling rose	BS 67	

**Objective of CE marking.**

CE marking is a “technical passport” which indicates that a product conforms to all relevant directives which require CE marking, thus enabling the product to travel within the E.U.

A directive is a piece of mandatory European Legislation implemented by regulations in all member countries. Its purpose is to allow free movement of goods that are safe and fit for use into and within the European Union.

CE marking is not a quality mark and it does not indicate that any testing or certification has been carried out.

**The marking.**

CE marking is a statement by the manufacturer that the product complies with the essential requirements of all relevant Directives, notably in the area of technical safety and conformity assessment.

CE marking can appear on the product or packaging or documentation or combination thereof dependant upon which directive it has to comply with.

CE marking is a very specific graphical symbol and must be clearly separated from other marks.

**Directives.**

It is the responsibility of the manufacturer or his authorised representative who places the product onto the EC market to decide which Directive(s) apply and to ensure the CE marking is affixed by the dates stated in the relevant directive(s)

For the majority of Hager products only one directive is applicable this is referred to as the Low Voltage Directive. Where some products incorporate electronic devices the Low voltage Directive and the Electromagnetic Compatibility Directive are applicable.

**The low voltage directive.**

EC directives are requirements adopted by the European Council and published in the official journal of the European Communities and are addressed to the member states.

European Council Directive 73/23/EEC with an amendment 93/68/EEC is known as the Low Voltage Directive.

The low voltage directive has been implemented into UK law by the “Electrical Equipment (Safety) Regulations 1994” and apply to all electrical / electronic equipment operating at a voltage of 50-1000 V a.c. or 75-1500 V d.c.. They do not apply to plugs, socket outlets and adapters which are covered by the Plugs and Sockets (Safety) Regulations 1994.

**Relationship between the Electrical Equipment (Safety) Regulations, Harmonised standards and the IEE Wiring Regulations Sixteenth Edition.**

The Electrical Equipment (Safety) Regulations requires electrical equipment to be safe. Electrical equipment which satisfies the safety provisions of Harmonised standards shall be taken to comply with this requirement, unless there are reasonable grounds for suspecting that the equipment does not so comply.

Regulation 511-01-01 of BS 7671 Requirements for Electrical Installations, IEE Wiring Regulations Sixteenth Edition requires every item of equipment to comply with the relevant requirements of the applicable British Standard, or Harmonised Standard appropriate to the intended use of the equipment.

The Ingress Protection (IP) for all low voltage enclosures up to 1000 V a.c. and 1500 V d.c. is defined in identical fashion by the standards EN 605 29 - IEC 529 it comprises the letters IP followed by two character numerals:



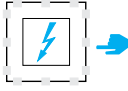
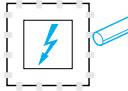
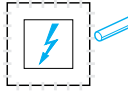
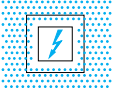
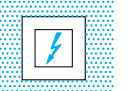

**The first character numeral** indicated the degree of protection provided by the enclosure with respect to persons, also to the equipment inside the enclosure.

**The first character numeral:**  
protection against solid substances

IP	Description
0	Non-protected
1	 Protected against solid objects greater than 50mm
2	 Protected against solid objects greater than 12.5mm
3	 Protected against solid objects greater than 2.5mm
4	 Protected against solid objects greater than 1.0mm
5	 Dust-protected
6	 Dust-tight

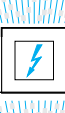
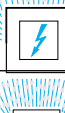
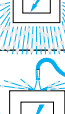
**The second character numeral** indicated the degree of protection provided by the enclosure with respect to harmful ingress of water; a third character may be used to indicate mechanical strength. An x signifies that no test has been carried out.

**The second character numeral:**  
protection against liquid substances

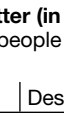
IP	Description
0	Non-protected
1	 Protected against dripping water
2	 Protected against dripping water when tilted up to 15°
3	 Protected against spraying water
4	 Protected against splashing water
5	 Protected against water jets
6	 Protected against heavy seas
7	 Protected against the effect of immersion
8	 Protected against submersion

**Additional letter (in option)**

Protection of people against access to dangerous parts

	Description
A	Protected against access of the back of the hand
B	Protected against access of a finger
C	Protected against access of a tool - ø 2.5mm
D	Protected against access of a tool - ø 1mm

**Additional letter (in option)**

Specific information on the product

	Description
H	High voltage material
M	Movements during water test
S	Stationary during water test
W	Bad weather

**One way switch**

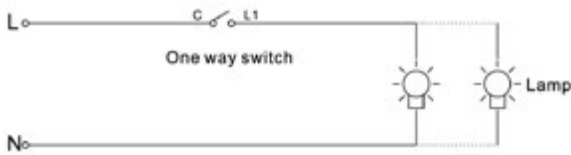

**Two way switch**

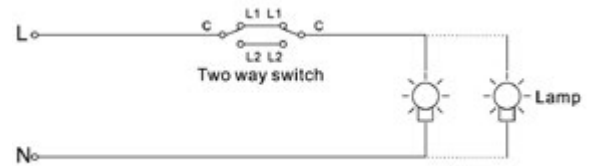

**Marked BELL switch**

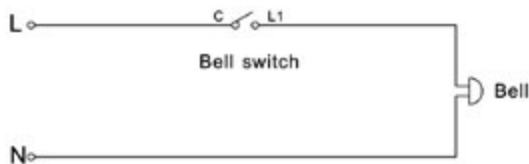

**Marked PRESS switch**

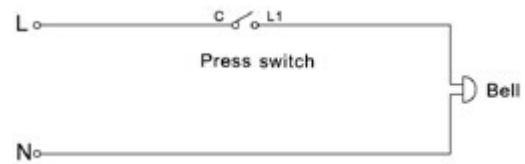

**Intermediate switch**

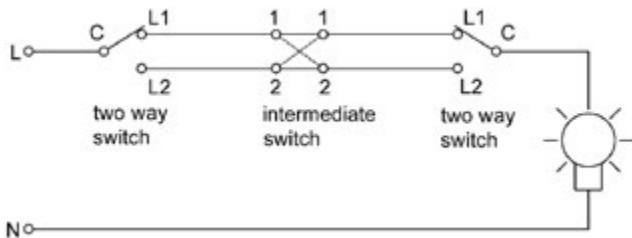

**Fan control**

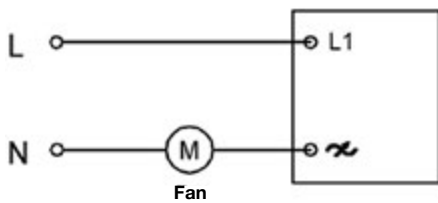

**Audio switch**

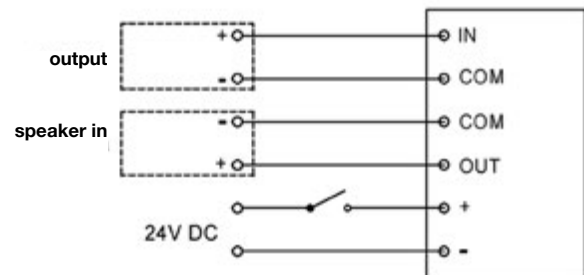

**Dimmer switch**

**1. One way connection**

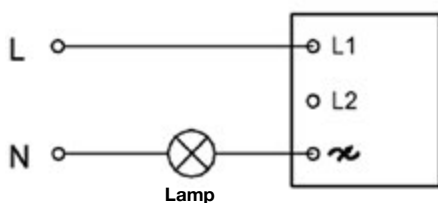

**2. Two way connection**

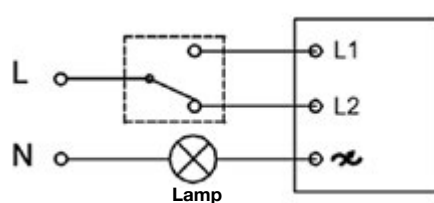

Do not disturb and please clean the switch (inside the door) / Do not disturb and please clear the instructions and the doorbell switch (outside the door)

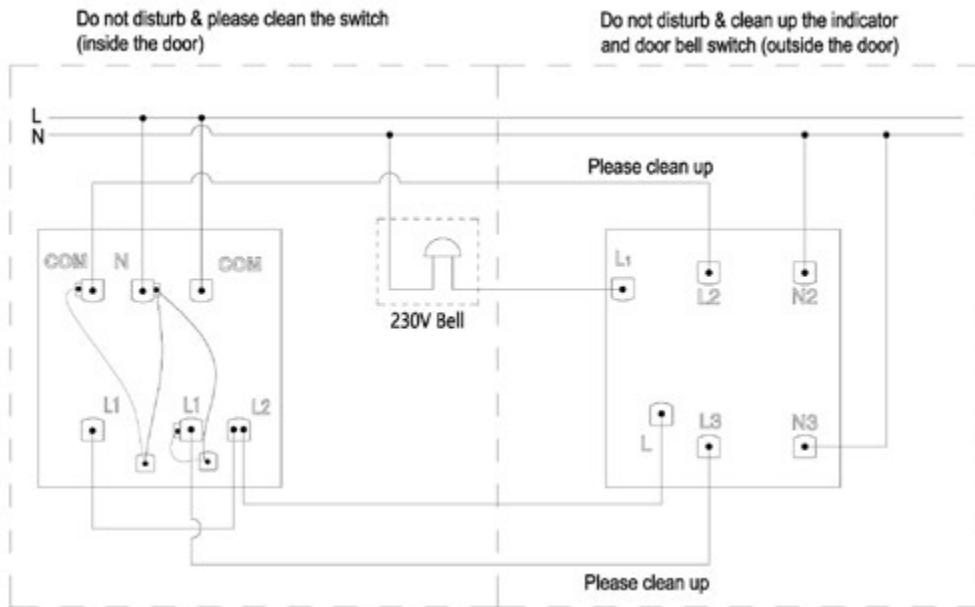

RJ45 Computer module cable diagram EIA/TIA 568B

RJ11 Telephone plug-in module cable diagram

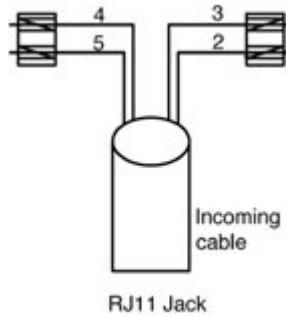
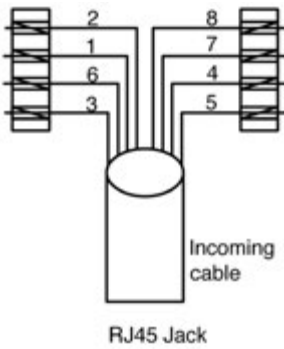

RJ45 Jack pin. EIA/TIA 568B	EIA/TIA 568A
1 White/Orange	White/Green
2 Orange	Green
3 White/Green	White/Orange
4 Blue	Blue
5 White/Blue	White/Blue
6 Green	Orange
7 White/Brown	White/Brown
8 Brown	Brown

RJ11 Jack pin.
2 Blue/White
3 White/Blue
4 White/Red
5 Red/White



**Key card**  
Direct load

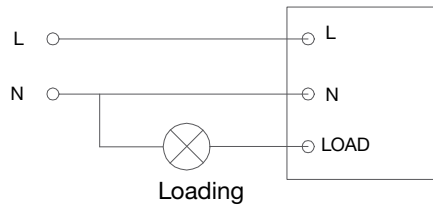

**Key card**  
Connected load through contactor

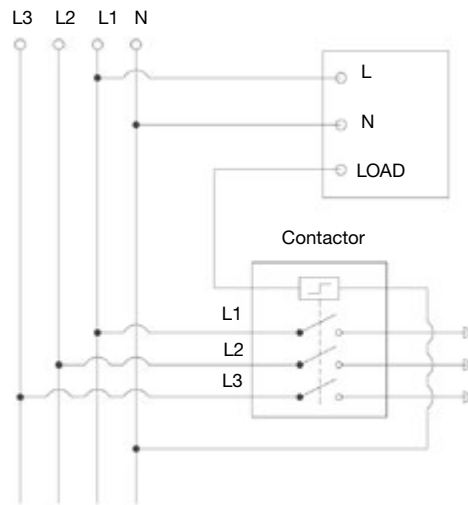

# Residential application

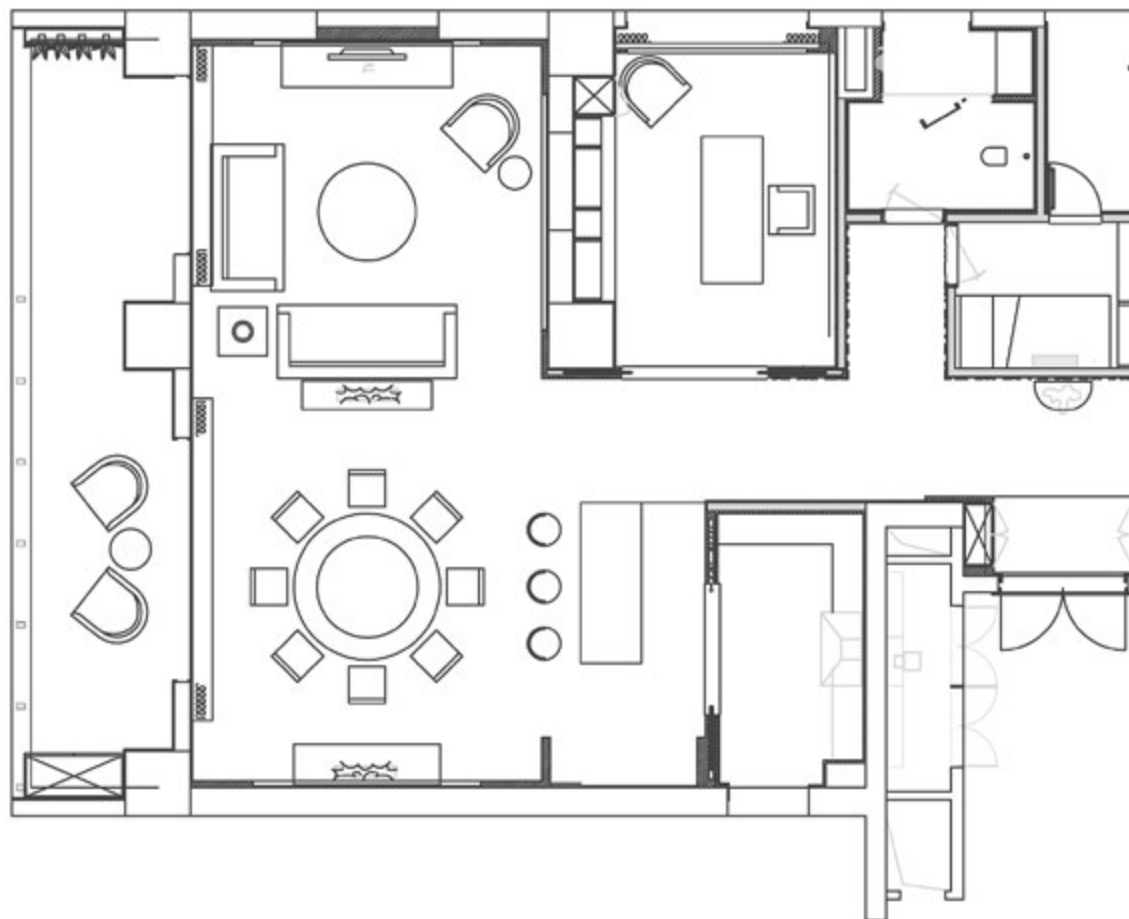

## Home garden / dining room

### Product catalog

200W Infrared sensor switch fire control	1
13A single switched socket	2
13A twin socket	2
13A single switched socket + 2 x USB chargers	1
16AX 1 gang 1 way switch	1
16AX 2 gang 2 way switch	1
16AX 2 gang 1 way switch	1
RJ11 outlet, 1 mod	1
RJ45 cat6 outlet	1
TV outlet, 1 mod	1
2 gang horizontal frame	2
5 gang horizontal frame	1

## Restaurant / kitchen

### Product catalog

Product catalog	QTY
13A single switched socket	8
13A twin socket	2
13A single switched socket + 2 x USB chargers	1
16AX 2 gang 2 way switch	1
16AX 2 gang 1 way switch	1
TV outlet, 1 mod	1
3 gang horizontal frame	2

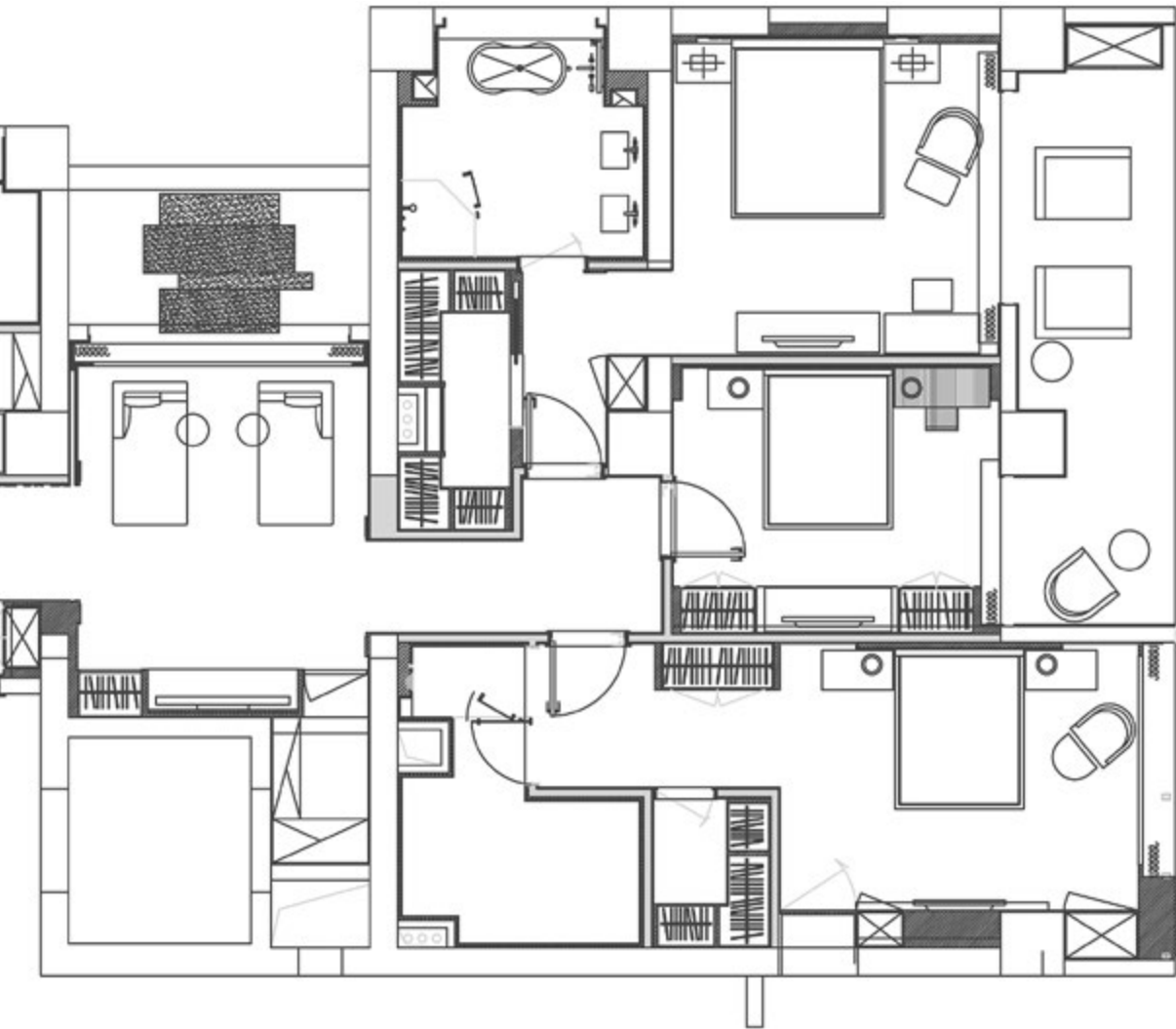

**Bedroom / dressing room / study room**

**Product catalog**

- 10AX 1 gang intermediate
- 13A twin socket
- 13A single switched socket + 2 x USB chargers
- 16AX 2 gang 1 way switch
- RJ11 outlet, 1 mod
- RJ45 cat6 outlet
- TV outlet, 1 mod
- Sleeping light

**QTY**

- 2
- 2
- 1
- 1
- 1
- 1
- 1
- 2

**Bathroom / balcony**

**Product catalog**

- 16AX 2 gang 1 way switch
- 13A single switched socket
- Blank plate
- WA cover (IP55)

**QTY**

- 1
- 2
- 4
- 2

# Hotel application

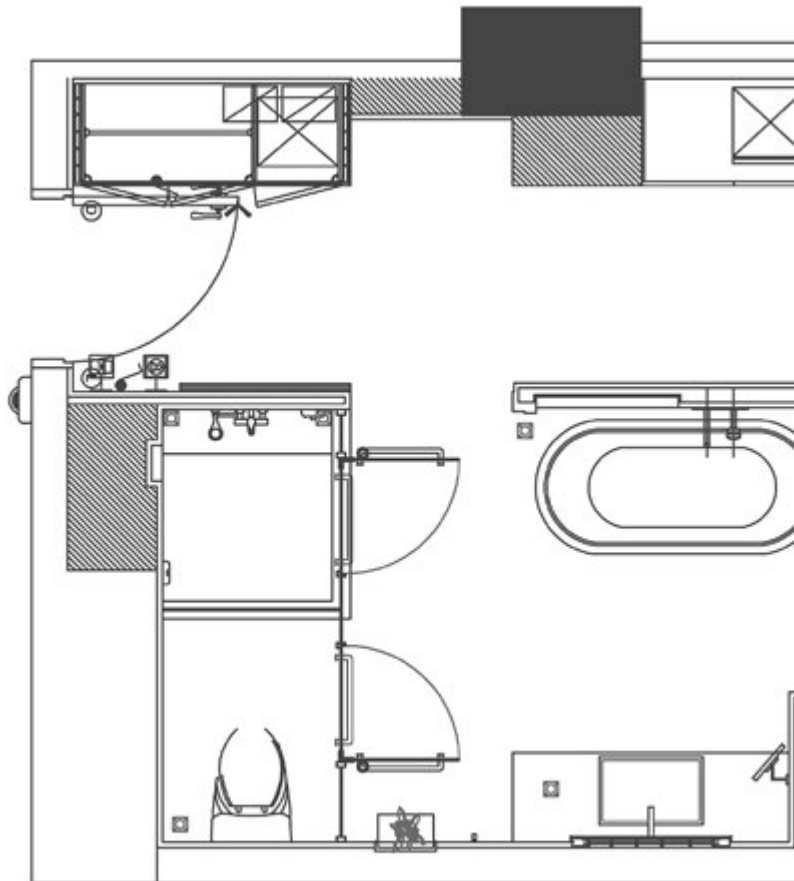

## Entrance / Bar counter

### Product catalog

4A DND & MUR indicator w/ bell switch  
 16A key tag RFID  
 16AX 1 gang 1 way LED switch  
 16AX 2 gang 2 way LED switch  
 13A single switched socket

### QTY

1  
 1  
 1  
 1  
 3

## Bed

### Product catalog

16AX 2 gang 1 way w/ LED switch  
 13A single switched socket, 2 x USB chargers  
 13A single switched socket  
 40-500W 2 way dimmer  
 RJ11 outlet, 1 mod  
 RJ45 ca5e outlet  
 Sleeping light

### QTY

1  
 1  
 2  
 2  
 1  
 1  
 1

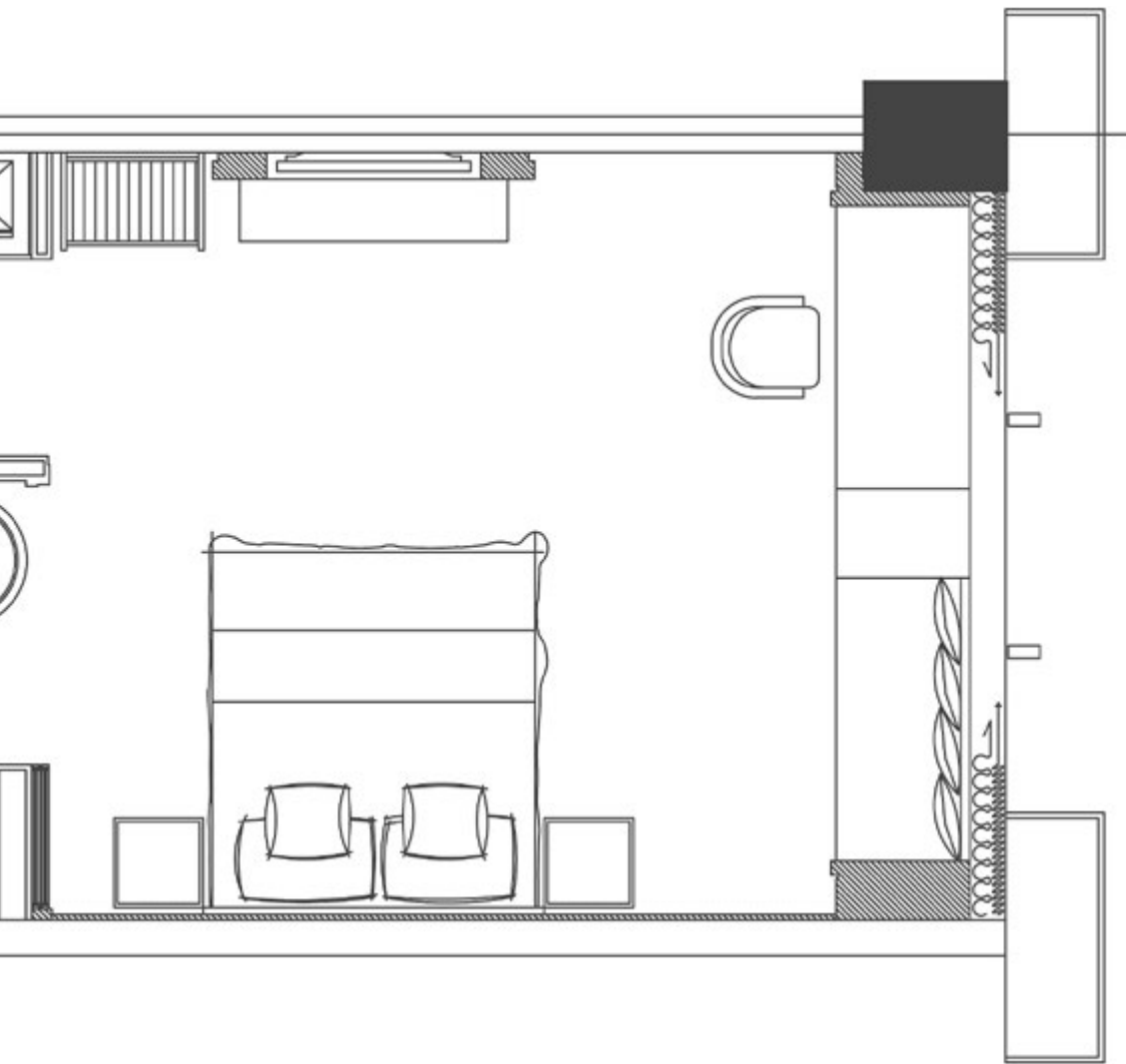

**Desk**

**Product catalog**

- 16AX 2 gang 1 way w/ LED switch
- HDMI+VGA
- 13A single switched socket + 2 x USB chargers
- 13A single switched socket
- RJ11 outlet, 1 mod
- RJ45 cat6 outlet

**QTY**

- 1
- 1
- 1
- 2
- 1
- 1

**Bathroom**

**Product catalog**

- 16AX 2 gang 1 way w/ LED switch
- Shaver socket
- Sleeping light
- SOS emergency switch
- 6W Audio switch
- 13A single switched socket
- RJ11 outlet, 1 mod
- WA cover (IP55)

**QTY**

- 2
- 1
- 1
- 1
- 1
- 3
- 1
- 4

# Office application

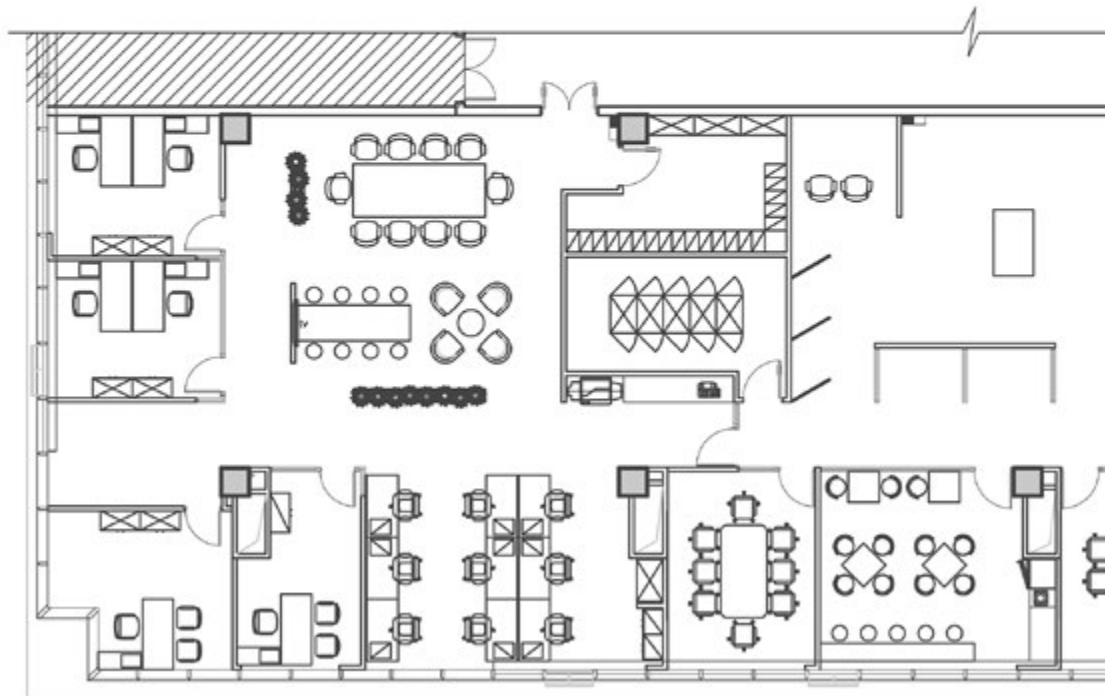

## Single office

### Product catalog

16AX 1 gang 1 way switch	8
16AX 2 gang 2 way switch	16
13A single switched socket	48
13A single switched socket + 2 x USB chargers	8
RJ45 cat6 outlet	16
HDMI+VGA	8
6A Audio switch	8
2 gang horizontal frame	16
3 gang horizontal frame	16

## Open area office

### Product catalog

Product catalog	QTY
16AX 1 gang 1 way switch	6
16AX 3 gang 1 way switch	10
16AX 4 gang 1 way switch	8
13A single switched socket	100
RJ11+RJ45 ca5e outlet	50
6A Audio switch	8
2 gang horizontal frame	6
3 gang horizontal frame	54

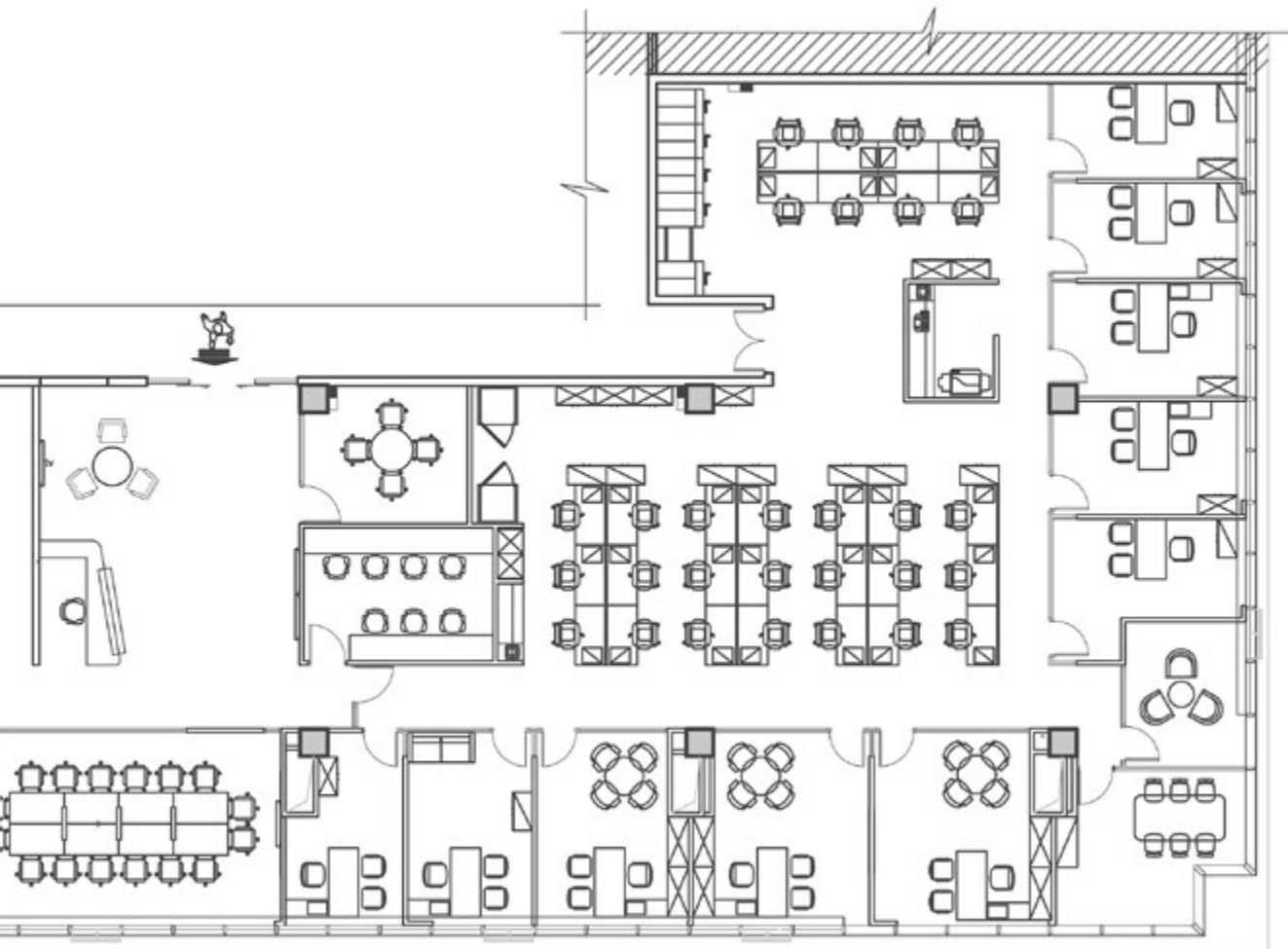

### Meeting room

#### Product catalog

16AX 1 gang 1 way switch	2
16AX 2 gang 1 way switch	4
16AX 3 gang 1 way switch	4
13A single switched socket	20
RJ11 outlet	2
RJ45 ca6 outlet	12
HDMI+VGA	1
3 gang horizontal frame	6
4 gang horizontal frame	54

### Public area: reception/ corridor/ pantry/ washroom

#### Product catalog

Product catalog	QTY
Sleeping light	12
13A single switched socket	12
200W Infrared sensor switch fire control	16
WA cover (IP55)	4

# Success cases

The courage to try to innovate in architectural design; the design of excellence always brings together a lot of ideas; the pursuit of the ultimate detail and the admiration of superior quality. Today, whether in Munich, Berlin and Hamburg, or in Bolzano, Madrid and Seoul, these ideas can be traced in any building in the world. It is no coincidence that Hager switches and systems can be found in all of these places.

## **Africa**

Crystal Cove Hotel, Hurghada, Egypt  
Somabay, Hurghada, Egypt  
Hotel Princess, Eilat, Israel  
Sea Park hotel, Netanya, Israel  
Mövenpick Resort & Spa Tala Bay, Aqaba, Jordan  
Park Inn by Radisson Nairobi Westlands, Nairobi, Kenya  
Radisson Blu Nairobi Upper Hill, Nairobi, Kenya  
Hotel Carlton, Antananarivo, Madagascar  
La maison des oliviers Hôtel, Marrakech, Morocco  
Serena - Polana Mar hotel, Maputo, Mozambique  
Grand Plaza Hotel, Nampula, Mozambique  
Pemba Express Hotel, Pemba, Mozambique  
Transcorp Hilton Hotel, Abuja, Nigeria  
Sheraton Abuja Hotel, Abuja, Nigeria  
Sheraton Lagos Hotel, Ikeja Lagos, Nigeria  
Sheraton Hotel, Lagos, Nigeria  
POD Camps Bay Hotel, Cape Town, South Africa  
Parrot Hotel, Arusha, Tanzania  
Sleep in hotel, Dar es Salaam, Tanzania

## **China**

Sofitel Shenyang Lido, Shenyang  
New World Beijing Hotel, Beijing  
Fairmont Beijing, Beijing  
Marriott Nanjing South Hotel, Nanjing  
Grand Hyatt, Hangzhou  
Park Hyatt Ningbo Resort & Spa, Ningbo  
The Peninsula, Shanghai  
Le Royal Meridien Hotel, Shanghai  
Swissôtel Grand Shanghai, Shanghai  
Mandarin Oriental Pudong, Shanghai  
Sofitel Shanghai Sheshan Oriental, Shanghai  
JW Marriott, Hangzhou  
Four Points by Sheraton Bijie, Guizhou  
Kempinski Hotel, Yinchuan  
New World Wuhan Hotel Wuhan  
Mandarin Oriental Hotel Guangzhou  
Hyatt Place Shenzhen Airport, Shenzhen  
The Ritz-Carlton, Shenzhen  
InterContinental, Shenzhen  
Swissôtel, Foshan  
Shangri-La's Sanya Resort & Spa, Hainan

## **Hong Kong & Macau**

Sheraton Hotel Tung Chung  
Island Shangri-La, Hong Kong  
Penta Hotel  
Hotel ICON  
Royal Plaza Hotel  
Ritz Cariton Hotel  
Best Western Hotel (Causeway bay & Tsim Sha Tsui)  
Harbour Grand Hong Kong  
Hyatt Regency Hotel  
Harbourview Horizon Hotel  
Royal View Hotel  
Grand Lisboa Macau  
Studio City Macau  
Galaxy Macau

## **Singapore**

Grand Hyatt Hotel  
Goodwood Park  
Park Regis  
Ramada & Days Hotel Singapore at Zhongshan Park  
Hotel Fort Canning

## **Indonesia**

Westin Hotel, Jakarta  
Courtyard by Marriott, Bali  
Fairfield by Marriott Sunset Road, Bali  
The Ritz-Carlton, Bali Resort & Spa, Bali

## **Vietnam**

Novotel Nha Trang  
Sealink Phan Thiet  
Sheraton Da Nang  
Radison Blu Cam Ranh  
Movenpick Cam Ranh  
Melia Cam Ranh  
Hanoi Hotel

## **India**

Taj Palace, Mumbai  
Hyatt Place, Hyderabad  
Ritz Carlton Pune, Pune  
Lemon Tree, 3 hotels (Udaipur, Dehradun, Kolkata)  
Fairfield Marriott Kolkata, Kolkata

## **Malaysia**

Genting Hotel, Genting Highlands  
JW Marriott Hotel, Kuala Lumpur  
WEIL Hotel Ipoh, Perak  
Alila Bangsar Kuala Lumpur, Kuala Lumpur  
Hilton Garden Inn Puchong, Selangor  
Alwaqf Hotel, Kelantan  
Kimberley Hotel, Penang  
Iconic Hotel, Penang  
VE Hotel & Residence, Bangsar South, Kuala Lumpur

## **Europe**

Hotel Sacher, Vienna  
Hotel Lux Alpinae, St. Anton am Arlberg  
Hotel Schloss Elmau, Elmau  
Vigilius Mountain Resort, Lana  
Hotel Puerta l'America, Madrid  
Lloyd Hotel, Amsterdam  
Zentrum für Virtuelles  
Engineering ZVE, Stuttgart  
Herzogin Anna Amalia Bibliothek, Weimar  
minimum bulthaup, Berlin  
PrivatHaus, Berlin  
Hyatt Regency, Istanbul  
Şişli Marriott, Istanbul  
Sheraton Ateşehir, Istanbul  
Swissôtel, Istanbul  
Le Meridien, Istanbul  
Hilton, Izmir  
Crowne Plaza, Istanbul

## **Other Countries**

Sedona Hotel, Mandalay, Myanmar  
Four Seasons Hotel, Seychelles  
Makati Shangri-La Hotel, Manila







### Hager Dream



### Hager Silhouette



### Berker R.1



### Berker R. Classic



### hagerblu visage



### Berker B.IQ



### Hager golf



### Hager witty



# Hager Design turns technical products into familiar friends.



**International designer Erwin van Handenhoven has been working with Hager since 2000 and his designs have repeatedly won international design awards. Erwin became the Product Design Director of Hager Group in 2013, focusing on shaping the future of Hager products and brands, making Hager design an international vane.**

Before we start designing a new product, we think about the people it is going to serve. Will it assist or entertain, observe or protect, save time or save energy? Ideally, whatever it does, users will feel it is a reliable "friend". We need to know how to connect with people on an emotional level, to ensure that in return they feel connected to our products.

Design links exquisite emotions to great usability and quality. How to illustrate this better than through this new Hager range? I designed it with special care to become a real trendsetter for good taste. We know that the Asian continent is constantly raising its design sensibility and quality expectations. It is exciting to create in this particular context where tradition and change operate together. This new design range will upgrade the standard of living in a clearly visible way. Hope you enjoy it as much as I do.

## Erwin van Handenhoven

Hager Group Design Director



**Hager Electro S.A.S**  
132 Boulevard d'Europe BP3  
67215 Obernai Cedex  
France

Tel: +33 (0) 3 88 49 50 50

[africa.hager.com](http://africa.hager.com)



20EN\_AF\_CAT\_MUSE