

collection kallysta pop

Révélez la couleur qui est en vous !



La petite touche
de caractère
qui change tout...

:hager



Avec kallysta pop, laissez parler votre caractère et jouez avec les couleurs dans votre intérieur.

La gamme kallysta pop permet de marier les tons et d'apporter une touche de caractère à votre déco. Composez votre partition et choisissez les couleurs qui vous ressemblent : vous serez sûrs de créer le décor parfait pour votre maison.

**la petite touche
de couleur
qui donne
du caractère**



Couleurs



lagon
Pages 6-7



citrouille
Pages 8-9



corail
Pages 10-11



granny
Pages 12-13



cobalt
Pages 14-15



cassis
Pages 16-17

Pastel



schiste
Pages 18-19



lin
Pages 20-21



opale
Pages 22-23

Monochromes



blanc névé
Pages 24-25



dune
Pages 26-27



titane
Pages 28-29



carbone
Pages 30-31

**La gamme
complète**
Pages 32



Les enjoliveurs
Pages 33



**Plaques
multipostes**
Pages 34-35

Guide de choix
Pages 36-44



lagon



WKN511

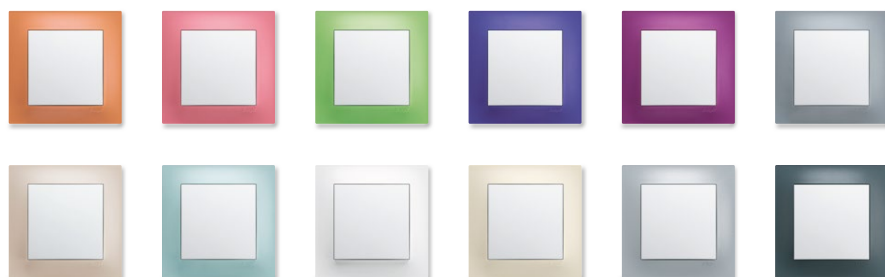



citrouille



WKN561

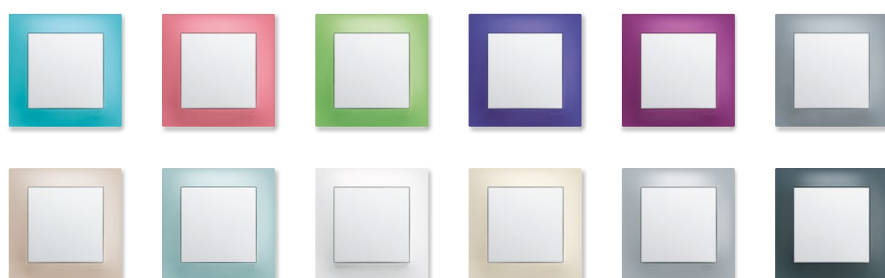

corail



WKN541

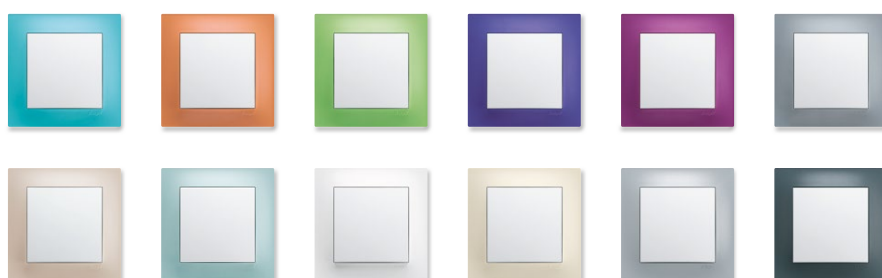





granny

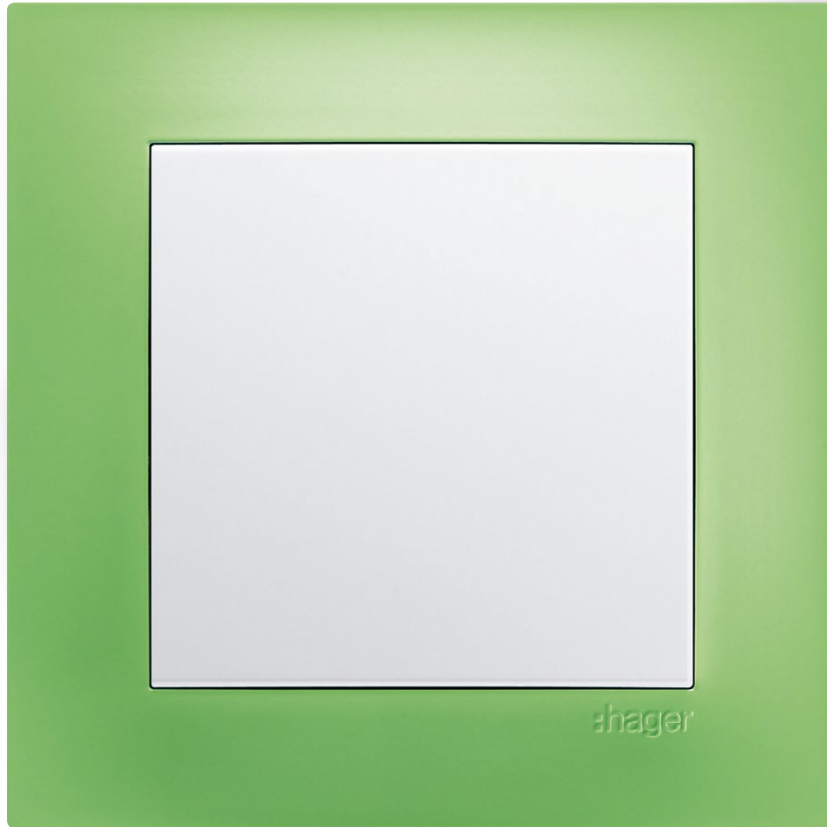

WKN551

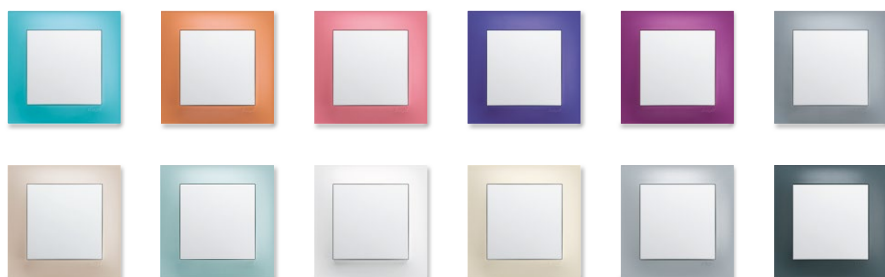

cobalt



WKN521

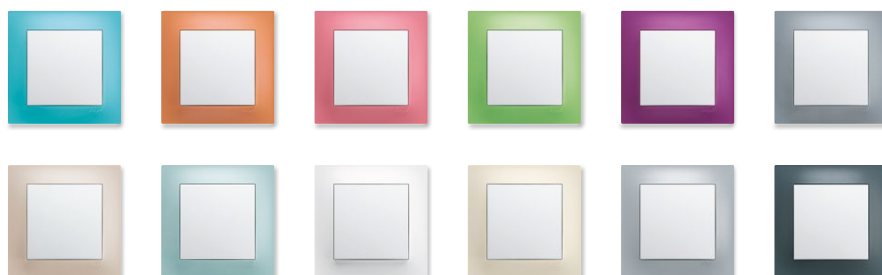





cassis



WKN531

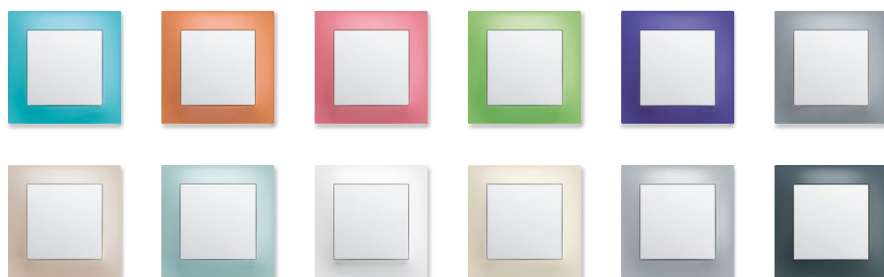

schiste

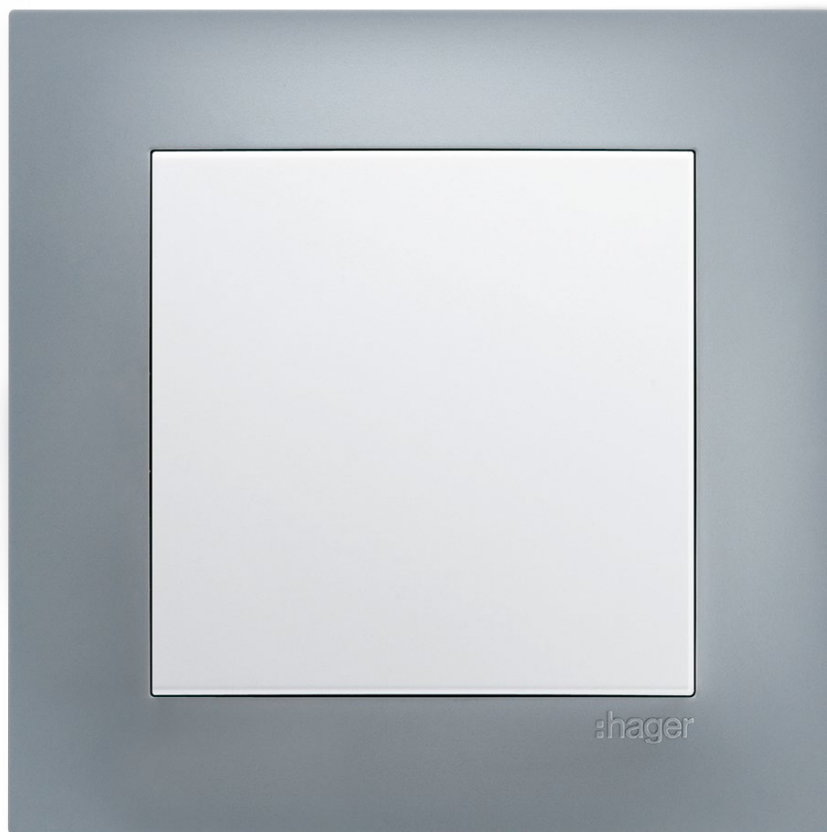

WKN421

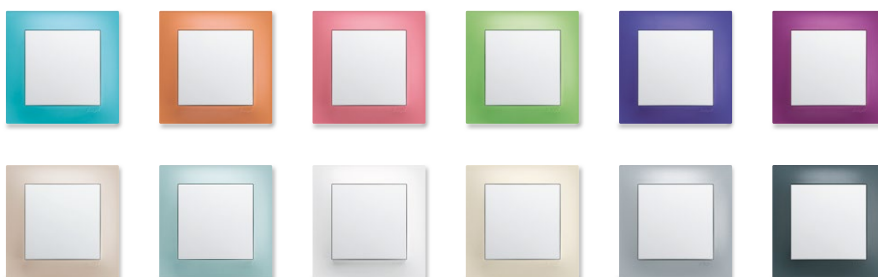





Dream



lin

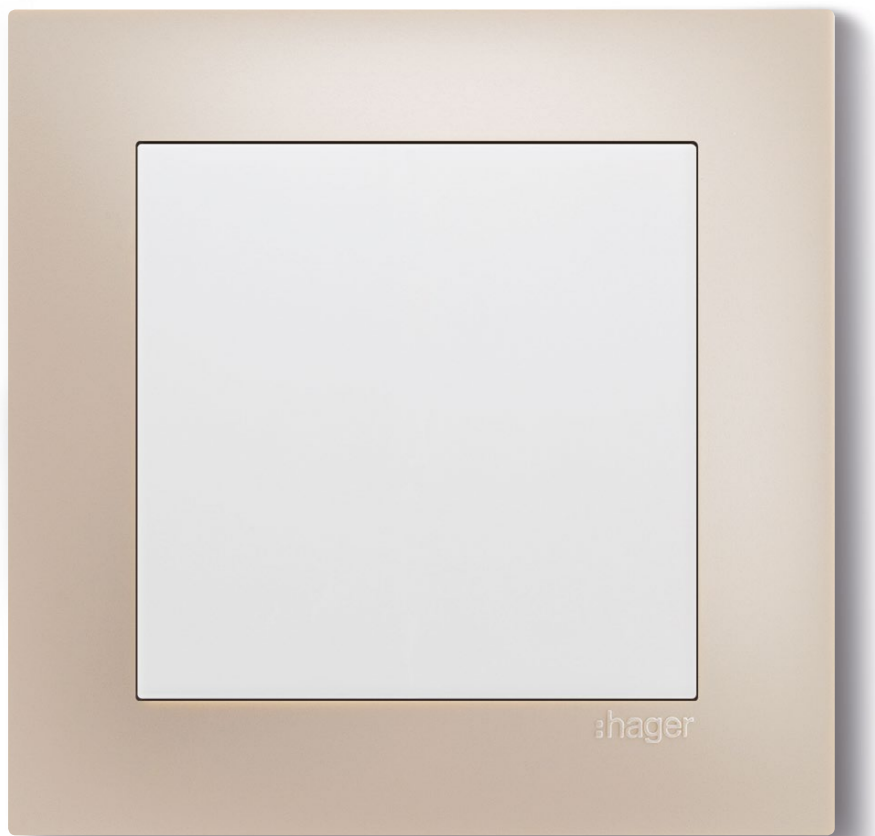

WKN441

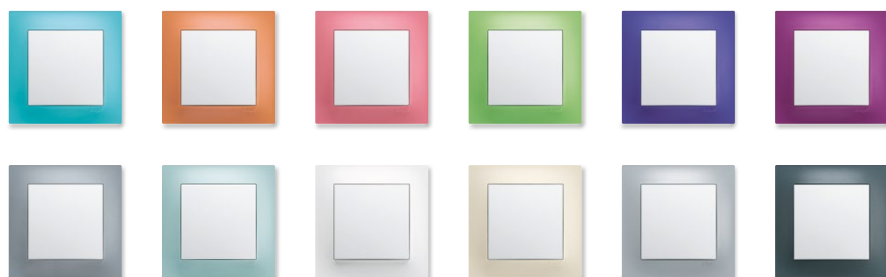



opale

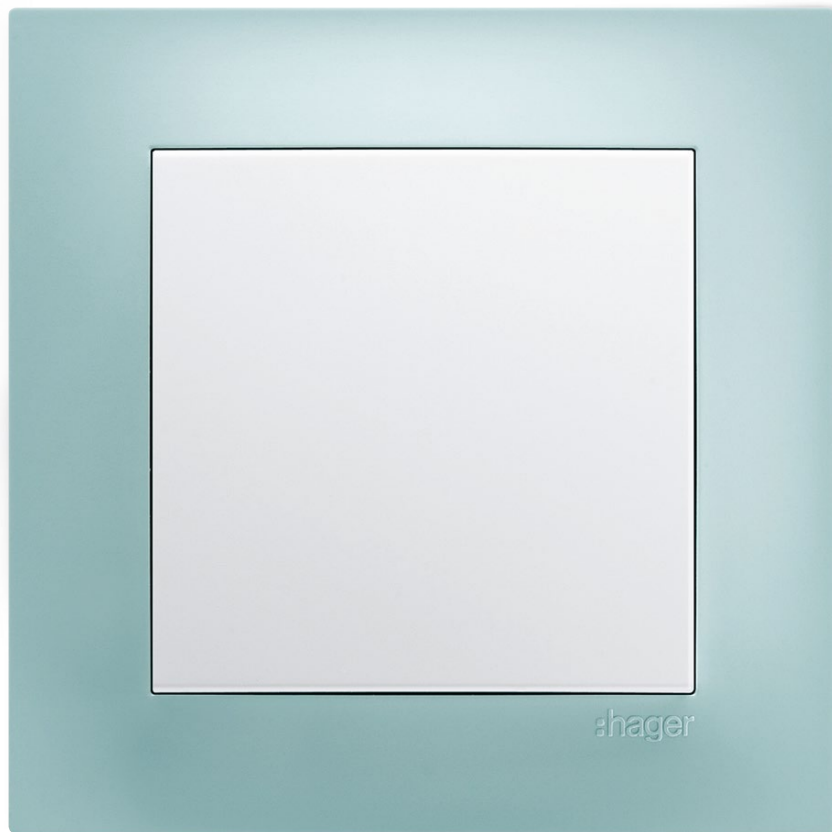

WKN431

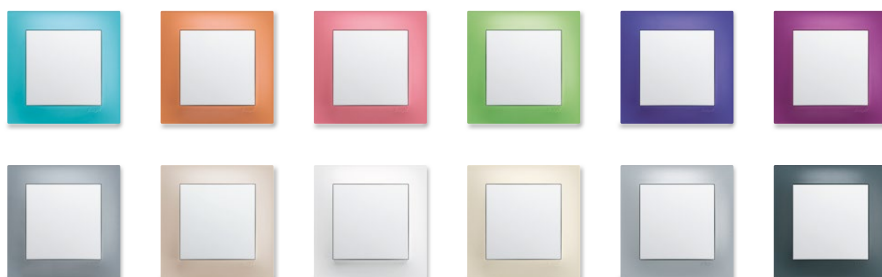



blanc névé

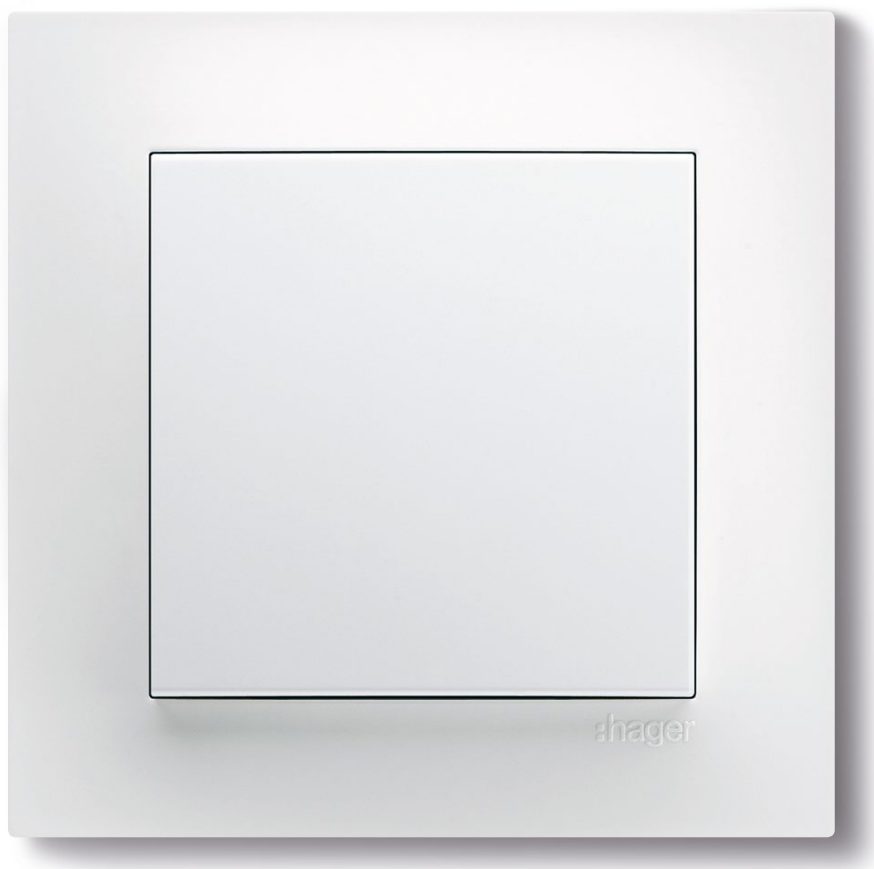

WKN401

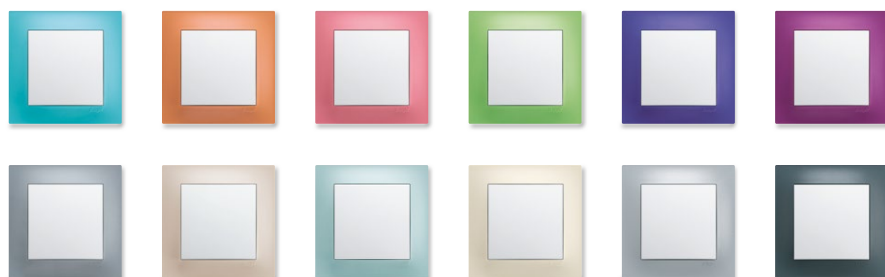

dune



WKN411

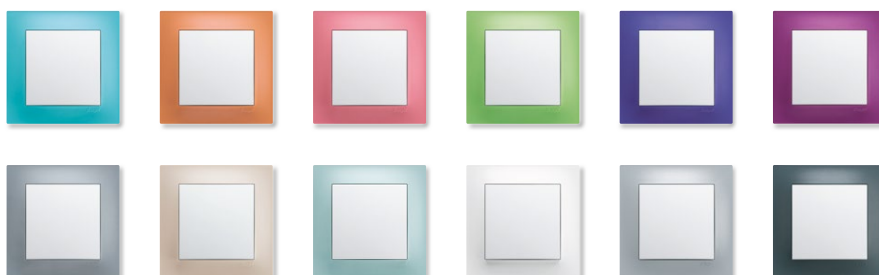





titane

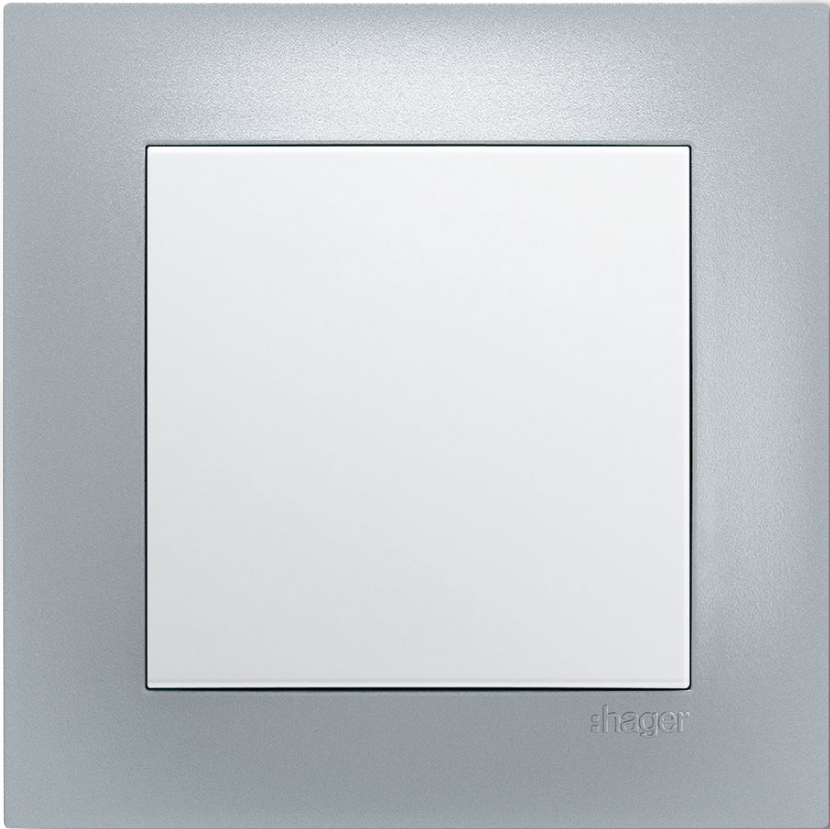

WKN491

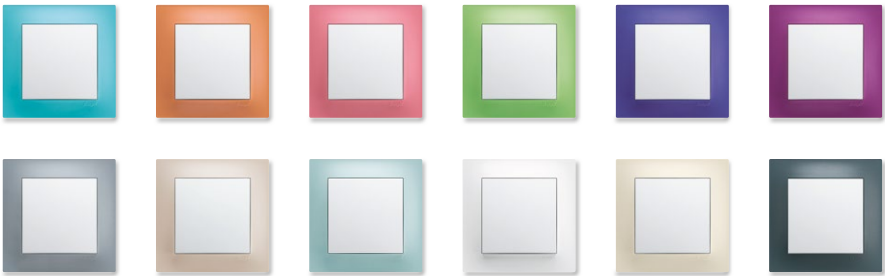



carbone

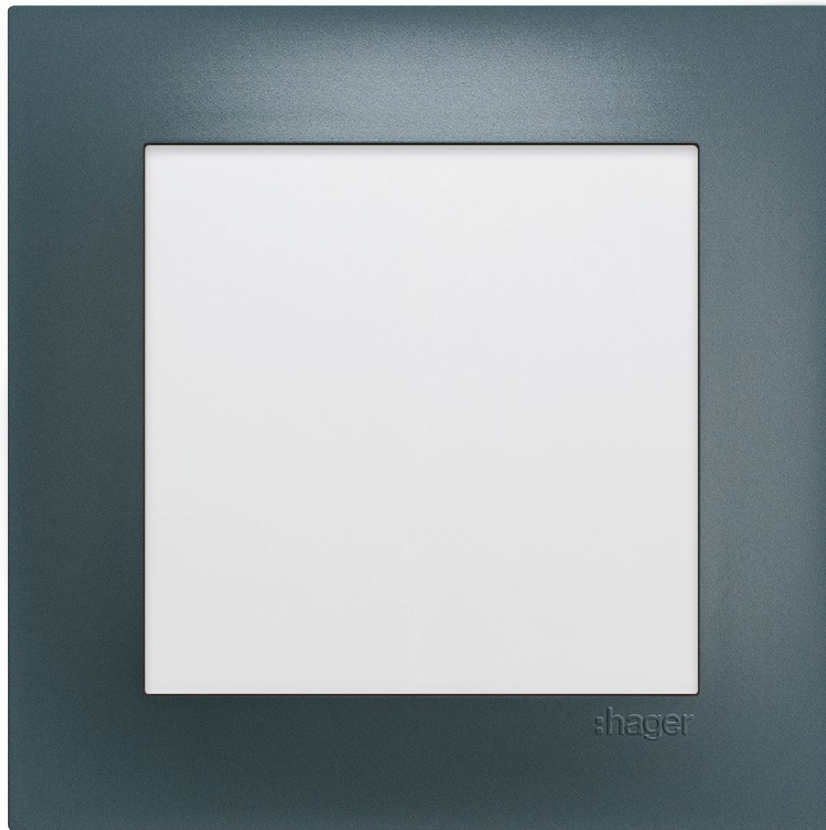

WKN501

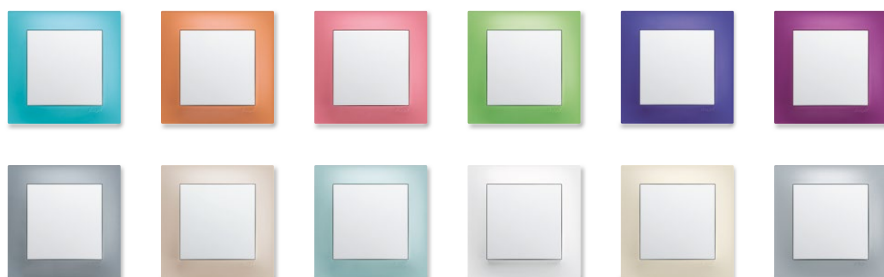

kallysta pop

Des harmonies audacieuses pour réveiller l'intérieur

13 variations

Couleur



lagon
WKN511



citrouille
WKN561



corail
WKN541

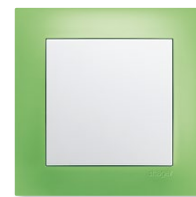

granny
WKN551

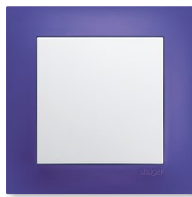

cobalt
WKN521



cassis
WKN531

Pastel



schiste
WKN421



lin
WKN441



opale
WKN431

Monochrome

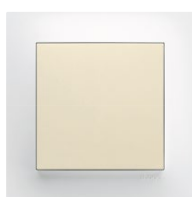

blanc névé
WKN401

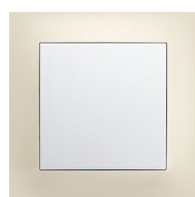

dune
WKN411



titane
WKN491

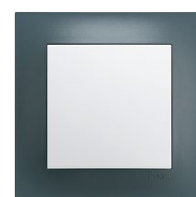

carbone
WKN501

8 enjoliveurs



névé
WK780B



titane
WK780T



carbone
WK780C



dune
WK780D



ekla
WK780M1



optik
WK780M2



graphik
WK780M3



barok
WK780M4

kallysta de long en large

Le design compact et fluide des multipostes apporte une véritable solution esthétique. En harmonie avec chaque style d'intérieur, les designs multipostes peuvent être installés dans le neuf comme en rénovation.

Disponible horizontalement (en 2, 3, ou 4* postes) ou verticalement (en 2 ou 3 postes). Offre multipostes entraxe 57 ou 71 mm.

Les prises doubles et triples kallysta sont précâblées en usine. Elles permettent l'alimentation et le repiquage sur chacun des puits pour répondre à toutes les situations rencontrées sur les chantiers.











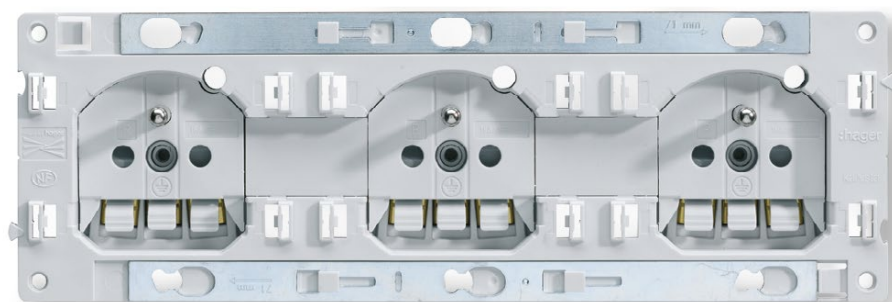
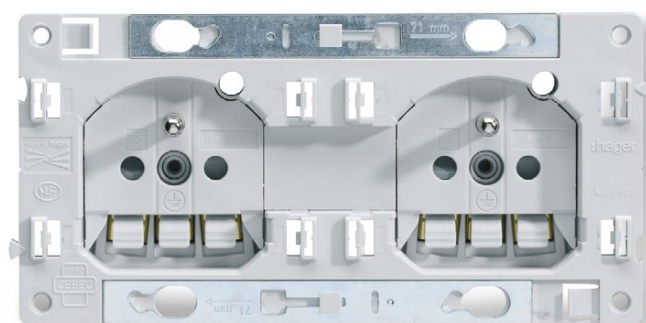









*pour certaines finitions





Un double avantage : gain de temps et facilité de câblage





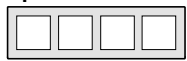

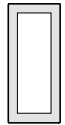

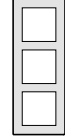

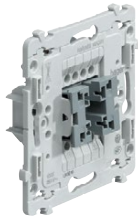













Les plus :

- Facilité de câblage en cas d'arrivées des tubes différentes.
- Rapidité de mise en œuvre.
- Idéal en rénovation même avec des conducteurs de faible longueur.
- Manettes de déconnexion protégées pour éviter une connexion accidentelle.























 Plaques pop		horizontal entraxe 71 mm								
		1 poste 88 x 88 mm  Réf. c ^{iale} Réf. num. Emb. pièces			2 postes 88 x 159 mm  Réf. c ^{iale} Réf. num. Emb. pièces			3 postes 88 x 230 mm  Réf. c ^{iale} Réf. num. Emb. pièces		
- blanc névé 		WKN401 716401	10	WKN402 716402	10	WKN403 716403	5			
- dune 	Pastel	WKN411 716411	10	WKN412 716412	10	WKN413 716413	5			
- schiste 	Pastel	WKN421 716421	1	WKN422 716422	1	WKN423 716423	1			
- opale 	Pastel	WKN431 716431	1	WKN432 716432	1	WKN433 716433	1			
- lin 	Pastel	WKN441 716441	1	WKN442 716442	1	WKN443 716443	1			
- titane 	Peinture métallisée	WKN491 716491	10	WKN492 716492	10	WKN493 716493	5			
- carbone 	Peinture métallisée	WKN501 716501	10	WKN502 716502	10	WKN503 716503	5			
- lagon 	Peinture satinée	WKN511 716511	1	WKN512 716512	1	WKN513 716513	1			
- cobalt 	Peinture satinée	WKN521 716521	1	WKN522 716522	1	WKN523 716523	1			
- cassis 	Peinture satinée	WKN531 716531	1	WKN532 716532	1	WKN533 716533	1			
- corail 	Peinture satinée	WKN541 716541	1	WKN542 716542	1	WKN543 716543	1			
- granny 	Peinture satinée	WKN551 716551	1	WKN552 716552	1	WKN553 716553	1			
- citrouille 	Peinture satinée	WKN561 716561	1	WKN562 716562	1	WKN563 716563	1			

4 postes 88 x 301 mm  Réf. c ^{iale} Réf. num. Emb. pièces			vertical entraxe 57 mm 2 postes 145 x 88 mm  Réf. c ^{iale} Réf. num. Emb. pièces			3 postes 202 x 88 mm  Réf. c ^{iale} Réf. num. Emb. pièces			vertical entraxe 71 mm 2 postes 159 x 88 mm  Réf. c ^{iale} Réf. num. Emb. pièces			3 postes 230 x 88 mm  Réf. c ^{iale} Réf. num. Emb. pièces		
WKN404 716404		1	WKN406 716406		1	WKN407 716407		1	WKN408 716408		10	WKN409 716409		5
WKN414 716414		1	WKN416 716416		1	WKN417 716417		1	WKN418 716418		10	WKN419 716419		5
WKN424 716424		1	WKN426 716426		1	WKN427 716427		1	WKN428 716428		1	WKN429 716429		1
WKN434 716434		1	WKN436 716436		1	WKN437 716437		1	WKN438 716438		1	WKN439 716439		1
WKN444 716444		1	WKN446 716446		1	WKN447 716447		1	WKN448 716448		1	WKN449 716449		1
WKN494 716494		1	WKN496 716496		1	WKN497 716497		1	WKN498 716498		10	WKN499 716499		5
WKN504 716504		1	WKN506 716506		1	WKN507 716507		1	WKN508 716508		10	WKN509 716509		5
WKN514 716514		1	WKN516 716516		1	WKN517 716517		1	WKN518 716518		1	WKN519 716519		1
WKN524 716524		1	WKN526 716526		1	WKN527 716527		1	WKN528 716528		1	WKN529 716529		1
WKN534 716534		1	WKN536 716536		1	WKN537 716537		1	WKN538 716538		1	WKN539 716539		1
WKN544 716544		1	WKN546 716546		1	WKN547 716547		1	WKN548 716548		1	WKN549 716549		1
WKN554 716554		1	WKN556 716556		1	WKN557 716557		1	WKN558 716558		1	WKN559 716559		1
WKN564 716564		1	WKN566 716566		1	WKN567 716567		1	WKN568 716568		1	WKN569 716569		1

Fonctions 	Mécanismes 	Touches  blanc névé  dune	
Interrupteurs :  10 AX - 250 V v IP2XC - va-et-vient	2 WK001	2 WK780B	2 WK780D
- va-et-vient à voyant		2 WK781B	2 WK781D
- va-et-vient porte-étiquette		2 WK782B	2 WK782D
- va-et-vient témoin avec neutre	2 WK003 	2 WK781B	2 WK781D
- va-et-vient à tirage	2 WK005* 	WK788B	WK788D
- bipolaire	2 WK006 	WK783B	WK783D
- bipolaire à voyant		WK784B	WK784D
- permutateur	2 WK010 	2 WK780B	2 WK780D
- carte hôtel	2 WK055 	WK762B	WK762D
Poussoirs :  10 AX - 250 V v IP2XC - inverseur	2 WK022 	2 WK780B	2 WK780D
- inverseur à voyant		2 WK781B	w WK781D
- porte-étiquette		2 WK782B	2 WK782D
- témoin	2 WK023 	2 WK781B	2 WK781D
- à tirage	2 WK024 livré avec cordon 	WK788B	WK788D
Doubles interrupteurs :  10 AX - 250 V v IP2XC - double va-et-vient	2 WK040 	2 WK785B	2 WK785D
- double va-et-vient à voyant	2 WK044 	2 WK786B	2 WK786D
- double poussoir inverseur		2 WK785B	2 WK785D
- double poussoir inverseur à voyant		WK786B	WK786D
- double poussoir porte-étiquette		WK787B	WK787D



titane	carbone	ekla	optik	graphik	barok
2 WK780T	2 WK780C	WK780M1	WK780M2	WK780M3	WK780M4
WK781T	WK781C	WK781M1	WK781M2	WK781M3	WK781M4
WK782T	WK782C	-	-	-	-
WK781T	WK781C	WK781M1	WK781M2	WK781M3	WK781M4
WK788T	WK788C	-	-	-	-
WK783T	WK783C	-	-	-	-
WK784T	WK784C	-	-	-	-
2 WK780T	2 WK780C	WK780M1	WK780M2	WK780M3	WK780M4
WK762T	WK762C	-	-	-	-
2 WK780T	2 WK780C	WK780M1	WK780M2	WK780M3	WK780M4
WK781T	WK781C	WK781M1	WK781M2	WK781M3	WK781M4
WK782T	WK782C	-	-	-	-
WK781T	WK781C	WK781M1	WK781M2	WK781M3	WK781M4
WK788T	WK788C	-	-	-	-
2 WK785T	2 WK785C	WK785M1	WK785M2	WK785M3	WK785M4
WK786T	WK786C	-	-	-	-
2 WK785T	2 WK785C	WK785M1	WK785M2	WK785M3	WK785M4
WK786T	WK786C	-	-	-	-
WK787T	WK787C	-	-	-	-

Fonctions 	Mécanismes 	Touches  blanc névé	 dune
Variateurs : 250 V v IP2XC - variateur rotatif	 2 WK060	2 WK790B	2 WK790D
- variateur à poussoir	 2 WK061	2 WK791B	2 WK791D
Interrupteurs automatique : IP2XC - infrarouge (2 fils)	 WK050	2 WK794B	WK794D
- infrarouge (3 fils)	 WK051	2 WK794B	WK794D
Commande de VMC : 10 AX - 250 V v IP2XC - va-et-vient	 WK001	2 WK798B	2 WK798D
- poussoir	 WK022	2 WK798B	2 WK798D
Commande de volets roulants : 10 AX - 250 V v IP2XC - double va-et-vient	 2 WK300	2 WK795B	2 WK795D
- double poussoir	 2 WK301	2 WK796B	2 WK796D
- commande locale de volets roulants électronique	 WK304	WK760B	WK760D
- commande centralisée de volets roulants programmable à afficheur	 WK305	WK761B	WK761D
Arrêt d'urgence : - avec clé	 WK032	WK744B	WK744D
- 1/4 tour	 WK033	WK744B	WK744D
Interrupteurs à clé : - 2 positions	 WK035	WK744B	WK744D
- 3 positions	 WK036	WK744B	WK744D
Thermostats électroniques : IP2XC - thermostat d'ambiance	 WK310	WK792B	WK792D
- thermostat fil pilote	 WK314	WK797B	WK797D



titane

carbone

ekla

optik

graphik

barok

WK790T

WK790C

WK790M1

WK790M2

WK790M3

WK790M4

WK791T

WK791C

-

-

-

-

WK794T

WK794C

-

-

-

-

WK794T

WK794C

-

-

-

-

WK798T

WK798C

-

-

-

-

WK798T

WK798C

-

-

-

-

WK795T

WK795C

WK795M1

WK795M2

WK795M3

WK795M4

WK796T

WK796C

WK796M1

WK796M2

WK796M3

WK796M4

WK760T

WK760C

-

-

-

-

WK761T

WK761C

-

-

-

-

WK744T

WK744C

-

-

-

-

WK744T

WK744C

-

-

-

-

WK744T

WK744C

-

-

-

-

WK744T

WK744C

-

-

-

-

WK792T

WK792C

-

-

-

-

WK797T































WK797C

-

-

-

-

Fonctions 	Mécanismes 	Enjoliveurs  blanc névé	 dune
Prises à éclipse : 10 AX - 250 V v IP2XC - prise 2P + T	 2 WK100	2 WK730B	2 WK730D
- double prise 2P + T	 2 WK122	2 WK730B	2 WK730D
- triple - prise 2P + T	 2 WK123	2 WK730B	2 WK730D
- prise 2P + T "connexion à vis"	 2 WK101	2 WK730B	2 WK730D
- prise 2P "connexion à vis"	 WK102	2 WK733B	2 WK733D
- prise 2P + T à associer à WUZ694	 2 WK100	2 WK731B	WK731D
- prise 2P + T détrompée	 2 WK105	enjoliveur rouge inclus dans la référence WK105	
- prise 2P + T détrompée "connexion à vis"	 2 WK106	enjoliveur rouge inclus dans la référence WK106	
Chargeur USB - chargeur 2 prises USB	 WK110	2 WK751B	2 WK751D
Sorties de câble obturateur - sortie de câble modulable	 2 WK155	2 WK739B	2 WK739D
- sortie de câble monobloc extraplate (pas de multiposte)	 2 WE155	monobloc : mécanisme inclus dans la référence WE154 pas de multiposte possible	
- obturateur - support 45 pour mécanisme systo	 2 WK157	2 WK780B 2 WK743B	2 WK780D 2 WK743D
- étanche monobloc IP44 : - blanche - titane - carbone	 WE154 WE154T WE154C	monobloc : mécanisme inclus dans la référence WE154 pas de multiposte possible	
Prises vidéo et son - 2 RCA audio - 3 RCA (audio + vidéo)	 2 WK268-WK261	2 WK744B	2 WK744D
- YUV (video RGB)	 2 WK262	2 WK744B	2 WK744D
- HDMI prise traversante	 2 WK263	2 WK751B	2 WK751D
- HDMI	 2 WK264	2 WK744B	2 WK744D
- USB	 2 WK265	2 WK744B	2 WK744D
- XLR femelle - XLR mâle	 2 WK266-WK267	2 WK744B	2 WK744D
- prise optique SC - prise optique LC	 2 WK270-WK271	2 WK751B	2 WK751D
- prise BNC	 2 WK273	2 WK751B	2 WK751D
- DVI-D	 2 WK274	2 WK744B	2 WK744D
- prise S-Video	 2 WK275	2 WK744B	2 WK744D
- SUB-D 15 (VGA)	 2 WK276	2 WK744B	2 WK744D
- Jack connector 3.5 mm	 2 WK278	2 WK751B	2 WK751D
- prise S-Video + Audio RCA	 WK279	2 WK744B	2 WK744D



titane	carbone	ekla	optik	graphik	barok
2 WK730T	2 WK730C	WK730M1	WK730M2	WK730M3	WK730M4
2 WK730T	2 WK730C	WK730M1	WK730M2	WK730M3	WK730M4
2 WK730T	2 WK730C	WK730M1	WK730M2	WK730M3	WK730M4
2 WK730T	2 WK730C	WK730M1	WK730M2	WK730M3	WK730M4
2 WK733T	2 WK733C	-	-	-	-
WK731T	WK731C	-	-	-	-
2 WK751T	2 WK751C	-	-	-	-
2 WK739T	2 WK739C	-	-	-	-
2 WK780T 2 WK743T	2 WK780C 2 WK743C	WK780M1	WK780M2	WK780M3	WK780M4
2 WK744T	2 WK744C	-	-	-	-
2 WK744T	2 WK744C	-	-	-	-
2 WK751T	2 WK751C	-	-	-	-
2 WK744T	2 WK744C	-	-	-	-
2 WK744T	2 WK744C	-	-	-	-
2 WK744T	2 WK744C	-	-	-	-
2 WK751T	2 WK751C	-	-	-	-
2 WK751T	2 WK751C	-	-	-	-
2 WK744T	2 WK744C	-	-	-	-
2 WK744T	2 WK744C	-	-	-	-
2 WK744T	2 WK744C	-	-	-	-
2 WK751T	2 WK751C	-	-	-	-
2 WK744T	2 WK744C	-	-	-	-

Fonctions 	Mécanismes 	Touches 			
		blanc névé	dune	titane	carbone
Prise téléphone - prise téléphone "T"	2 WK200	2 WK750B	2 WK750D	2 WK750T	2 WK750C
Prises informatique - prise RJ45 cat.5e UTP (grade 1) 	2 WK211	2 WK751B	2 WK751D	2 WK751T	2 WK751C
- prise RJ45 x 2 cat.5e UTP (grade 1) 	2 WK212	2 WK752B	2 WK752D	2 WK752T	2 WK752C
- prise RJ45 cat.5e FTP (grade 1) 	2 WK214	2 WK751B	2 WK751D	2 WK751T	2 WK751C
- prise RJ45 x 2 cat.5e FTP (grade 1) 	2 WK215	2 WK752B	2 WK752D	2 WK752T	2 WK752C
- prise RJ45 cat.5e STP (grade 1) 	2 WK217	2 WK751B	2 WK751D	2 WK751T	2 WK751C
- prise RJ45 x 2 cat.5e STP (grade 1) 	WK218	2 WK752B	2 WK752D	2 WK752T	2 WK752C
- prise RJ45 cat.6 UTP (grade 1) 	WK220	2 WK751B	2 WK751D	2 WK751T	2 WK751C
- prise RJ45 x 2 cat.6 UTP (grade 1) 	WK221	2 WK752B	2 WK752D	2 WK752T	2 WK752C
- prise RJ45 cat.6 FTP (grade 2) 	2 WK223	2 WK751B	2 WK751D	2 WK751T	2 WK751C
- prise RJ45 x 2 cat.6 FTP (grade 2) 	WK224	2 WK752B	2 WK752D	2 WK752T	2 WK752C
- prise RJ45 cat.6 STP (grade 3) 	WK226	2 WK751B	2 WK751D	2 WK751T	2 WK751C
- prise RJ45 x 2 cat.6 STP (grade 3) 	WK227	2 WK752B	2 WK752D	2 WK752T	2 WK752C
- prise RJ45 x 2 cat.6 STP (grade 2 TV) 	WK230	2 WK752B	2 WK752D	2 WK752T	2 WK752C
- prise RJ45 cat.6a STP (grade3 TV) 	WK228	2 WK751B	2 WK751D	2 WK751T	2 WK751C
Prises télévision - prise TV type F 	2 WK259	2 WK740B	2 WK740D	2 WK740T	2 WK740C
- prise TV directe 	2 WK250	2 WK740B	2 WK740D	2 WK740T	2 WK740C
- prise TV passage/terminal 10 dB 	2 WK251	2 WK740B	2 WK740D	2 WK740T	2 WK740C
- prise TV passage/terminal 15 dB 	2 WK252	2 WK740B	2 WK740D	2 WK740T	2 WK740C
- prise TV + FM directe 	2 WK253	WK741B	WK741D	WK741T	WK741C
- prise TV + FM passage/term.10 db 	WK254	WK741B	WK741D	WK741T	WK741C
- prise TV + FM passage/term.15 db 	WK255	WK741B	WK741D	WK741T	WK741C
- prise TV+FM+SAT directe 1 entrée 	2 WK256	2 WK742B	2 WK742D	WK742T	WK742C
- prise TV+FM+SAT directe 2 entrées 	WK257	2 WK742B	2 WK742D	WK742T	WK742C
- prise réseau câblé double F 	2 WK258	2 WK742B	2 WK742D	WK742T	WK742C
Prises Haut Parleurs - prise HP x 	2 WK290	2 WK751B	2 WK751D	2 WK751T	2 WK751C
- prise HP 2 x 1 	2 WK291	2 WK752B	2 WK752D	2 WK752T	2 WK752C
Plastron RJ45 pour moteur keystone - pour 1 RJ45 	2 WK202	2 WK751B	2 WK751D	2 WK751T	2 WK751C
- prise HP 2 x 1 	2 WK204	2 WK752B	2 WK752D	2 WK752T	2 WK752C



Hager Electro SAS

132 boulevard d'Europe
BP 3
67215 Obernai cedex
France

Tel: +33 (0)3 88 49 50 50
africa.hager.com