

vega D

enclosure

Smart board
for commercial
and residential
projects

:hager

vega D, a range with a market presence

Whether in hotels, offices, homes: Hager underline their presence in the service industry. From distribution enclosures and wall-mounted equipment to computing solutions, we provide a global range of products for service buildings with a view to energy performance.

The vega D enclosure is a new breakthrough. Between technology and design, the product takes its place in a tradition of reliability, security and simplicity, which is the hallmark of our product range.

The vega D range expresses the commitment of Hager to project managers and clients to implement specific solutions, customised and sustainable, that meet the most complex conditions of use and ongoing developments.

Proximity to the market and the ability to listen and to communicate is one of the strong points of the Hager Group. Our success is based on anticipating the expectations of our clients. By offering innovative and accessible solutions, we want to gain their trust, day by day.



Small business premises



For blue mono or tri tariffs for main switchboards.

Major service projects



For yellow or green tariffs for switchboards,



Simplicity, technology and design. Discover the vega D universe

The new enclosure conceived by Hager has an essential quality: it adapts to all situations and to all applications. From large service projects to small business premises, or for use in households.

To meet all demands, Hager conceived vega D, a range of distribution enclosures capable of excelling in all areas: efficiency, reliability, performance and simplicity.

A totally modular system for the service industry as well as for at home.

Expandable in height or in width from 2 to 7 rows, these products make it possible to create panels up to 160A.

The key word is the ability to adapt. vega D provides solutions for all project configurations, from large service conglomerates to small business premises, as well as for household use. A concentration of usages, combined in a single design, which offers speed and ease of operation. All commands are completely self-explanatory.

The system is easily accessible. vega D is a time-saving solution to optimise your electric infrastructure.

At home



For blue mono or tri tariffs for main switchboards.

Ideal for use at home where there are numerous electric circuits with or without home automation.



vega D, an enclosure to simplify your life

Mature technology and innovative solutions: Hager products are a guarantee for failsafe quality, security and reliability. As proof of this commitment, the new vega D enclosure focuses especially on simplicity of use: easy to operate, to adapt to project situations for impeccable final results. When everything is well-conceived and smart, it's simply Hager.



+ Easy

Simplified implementation

Practical and unique, the vega D enclosure combines Hager intelligence. From packaging to accessories, all equipment has been designed to simplify the operation of the electric infrastructure.

No futile efforts: all elements are spontaneously at hand, in a logic and natural order for unconstrained operation.

+ Flexible

Solution for all project configurations

The range of vega D enclosures offers a choice of multiple applications. All models have numerous specific installation solutions that allow perfectly smooth integration in all types of projects. Guaranteed comfort.

No other enclosure offers a comparable level of flexibility, powerful and evolutionary at the same time, which meets all expectations.

+ Pro

Impeccable outcome

The vega D range of enclosures expresses style and personality. With sober lines and a robust structure, the product stands out through timeless design and impeccable finish. A perfect model perfectly in sync with professional needs.

Benefits at every step of the installation process

1 Smart packaging

UNIQUE

Thanks to this very smart packaging, unpacking is easy, and storage of dismantled pieces has been improved.

Once the enclosure has been wired, the packaging can be reused in case the enclosure must be returned.

+ Easy



Easy unpacking



Storage of dismantled pieces



Reusable for shipping

2 Simplified installation

Horizontal or vertical combination

Thanks to a connecting kit, vega D enclosures can be combined horizontally or vertically as required for your project. They can be installed flat or directly on the ground.

+ Flexible



5th hole

A 5th hole facilitates installation, which can be carried out by a single person.



+ Easy

UNIQUE

3rd rail between 2 rows

Installation of a 3rd rail between 2 modular rows makes it possible to plug in a terminal strip outside the compartment of the modular devices.

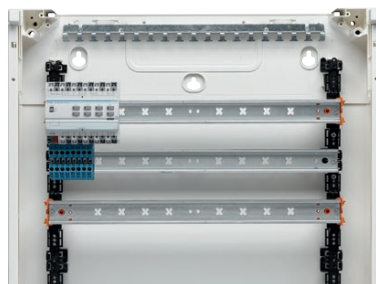

+ Flexible

Rapid assembly of systo accessories

The lateral parts are pre-cut and allow a quick knocking out, simply with a hammer.

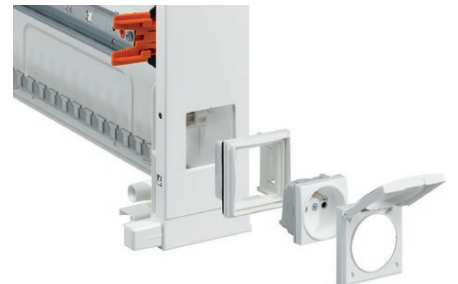

+ Easy

3 Simplified cabling

More space

- Better accessibility from the sides
- More space between the bottom of the enclosure and the DIN rail to allow for the passage of wires and cables.

+ Easy

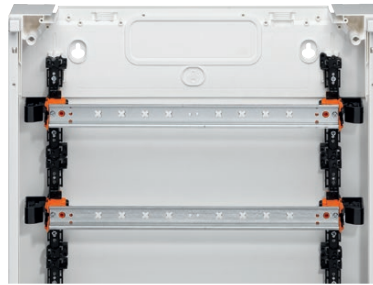

More space for cabling

+ 30 %
on the sides

+ 10 %
under the RMD

UNIQUE

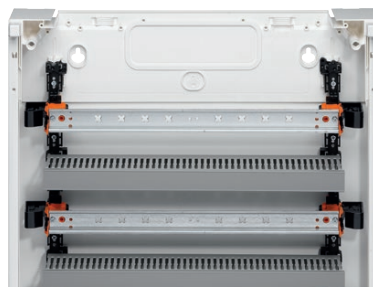

Clip-on cable trunkings

The cable trunkings can be clipped on horizontally or vertically, as needed. They are fixed without tools.

UNIQUE

Cable guide bracket
3-in-1 patented system



+ Pro

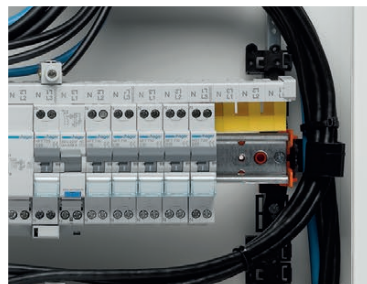

Traditional use as cable guide

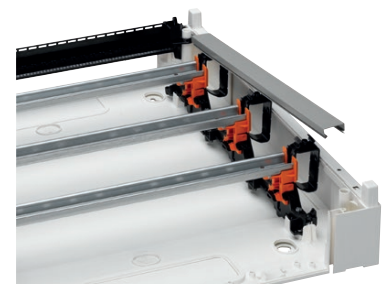

Holder for trunking cover

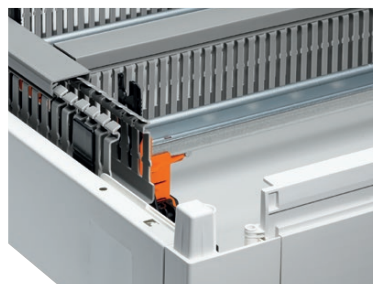

Fixation of the cable trunking

4 More flexible connection

NOUVEAU

Cable entry

The vega D enclosure has cable entries at the top, at the bottom and in the rear. These entries have been designed so as to provide you with maximum flexibility. Accessibility on the sides and at the rear has been designed to give you a maximum of freedom.



+ 40%
entrance
surface



Rear entry flange
mounting without tool

+ Flexible

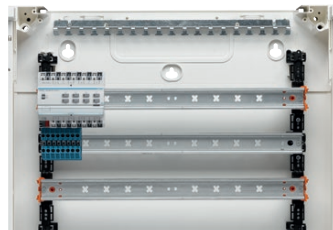

+ 30%
of available
space

5 Finition plus pro

UNIQUE

Clip-on labelling field

The labelling field can be clipped on above and/or below modular products. It is thus perfectly aligned and offers maximum space for labelling.



+ 70%
of available
space

+ Pro

Facilitated guide

Choice of two doors

Plain or transparent, the doors have an adjusting device to ensure perfect alignment with the enclosure hinges.

+ Pro



Plain or transparent door



Maximum protection

Lightweight, compact, solid, precise: the vega D enclosure combines multiple advantages. A product ideally designed to house and protect a range of Hager equipment, from circuit protection with the h3 series to modular protection with staggered or aligned terminals.

For business premises and at home

h3 MCCBs (moulded case circuit breakers)



Fixed version up to 160 A
with or without add-on block

Modular protections

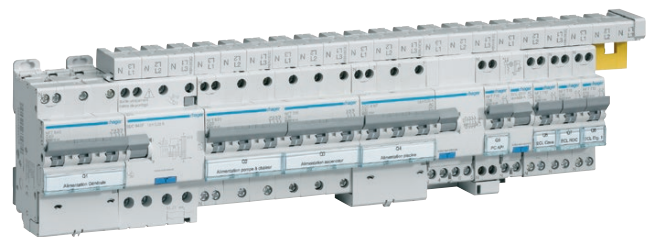

Staggered terminals up to 40 A



Aligned terminals up to 63 A



Your benefits

- Easy to install.
- Space saving.
- A versatile solution for the service industry and home environment.
- Delivery ready-for-use or to complete

Technical data

- Class II
- 2 to 7 rows of 24 modules
- Up to 160 A
- Degrees of protection: IP30 and IP41 with door (IP40 for flush with door)
- Can be joined horizontally and vertically

Configuration, guidelines



Surface mounted enclosures

FDx2GN

or

Flush mounted enclosures

FUx2GN



x: number of rows
5 rows: FD52DN and FD52AN

Applications with circuit breakers x160

FD02K1

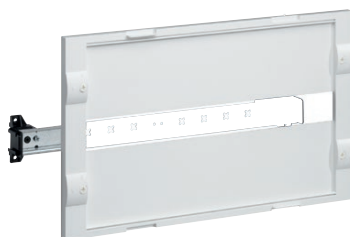

for circuit breakers
up to 160A0
with or without
differential unit
vertical mounting
(not included in delivery)

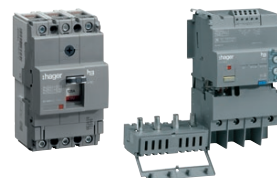

Special applications

FD02A3



with 1 standard rail and
1 depth-adjustable rail

FD02A2



with depth-adjustable rails

FD01K1



for circuit breakers
up to 160A without
differential unit
horizontal mounting
(not included in delivery)



Connecting kits



FD00F1

with for surface-mounted enclosures

vertical





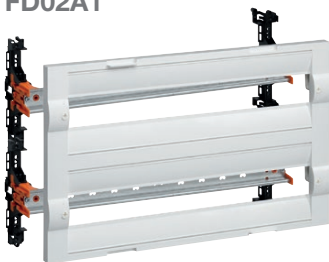

horizontal















FD02A1









2 modular rails

							
Surface-mounted enclosures	Characteristics						
Empty with 2 vertical uprights	Height rows	Width modules	Up to 160 A with or without differential unit. Mounted vertically. Height: 2 rows	Up to 160 A without differential unit. Mounted horizontally. Height: 1 row	For modular devices Height: 2 rows	For special devices delivered with perforated plate Height: 2 rows	For terminal strips Height: 2 rows
FD22GN	2	48	FD02K1	FD01K1	FD02A1	FD02C2	FD02A2
FD32GN	3	72					
FD42GN	4	96					
FD52GN	5	120					
FD62GN	6	144					
FD72GN	7	168					

							
Flush mounted enclosures	Characteristics						
Empty with 2 vertical uprights	Height rows	Width modules	Up to 160 A with or without differential unit. Mounted vertically. Height: 2 rows	Up to 160 A without differential unit. Mounted horizontally. Height: 1 row	For modular devices Height: 2 rows	For special devices delivered with perforated plate Height: 2 rows	For terminal strips or deeper devices Height: 2 rows
FU22GN	2	48	FD02K1	FD01K1	FD02A1	FD02C2	FD02A2
FU32GN	3	72					
FU42GN	4	96					
FU52GN	5	120					
FU62GN	6	144					
FU72GN	7	168					

							
Doors		Connecting kit for surface enclosure	External fixing brackets for surface enclosure	Cable entry plates top and bottom non-standard		Rear cable entry plate	Cable brackets for surface only
Plain	Transparent	Horizontal and vertical	Walls	IP41	For cable glands	IP41	Vertical as spare parts
FD22PN	FD22TN	FD00F1	FD00F2	FD00P2	FD00P3	VZ741	FD00B1
FD32PN	FD32TN						
FD42PN	FD42TN						
FD52PN	FD52TN						
FD62PN	FD62TN						
FD72PN	FD72TN						

						
Doors		Fixing brackets	Closing plates top and bottom non-standard		Rear cable entry plate	Cable brackets for flush only
Plain	Transparent	For hollow wall	IP41	For cable glands	IP41	Vertical to complete equipment kits for mounting into flush enclosures
FD22PN	FD22TN	VZ405N	FD00P2	FD00P3	VZ741	FD00B2
FD32PN	FD32TN					
FD42PN	FD42TN					
FD52PN	FD52TN					
FD62PN	FD62TN					
FD72PN	FD72TN					

- vega D enclosures surface-mounted**
1 to 7 rows,
24 I per row
equipped with :
- cable gland plates removable at top and bottom
 - removable modular body
 - removable frame
 - QuickConnect earthing strip (only DN version)
 - labelling strip
 - covers
 - drawing map (only DN version)

- vega D enclosures flush mounted**
1 to 7 rows,
24 I per row
equipped with :
- installation tray (depth: 110 mm) with cable entries
 - removable modular body
 - removable frame: 40 mm overhanging frame for FU*DN and FU*LN and 72mm overhanging frame for FU*GN
 - QuickConnect earthing strip (only DN version)
 - labelling strip
 - covers
 - drawing map (only DN version)

- Common data:**
- IP 30 / IK 07 (without door)
 - IP40 / IK 08 (flush version with door)
 - IP 41 / IK 08 (surface version with door)
 - class II
 - space between DIN rails: 150 mm



fire classification according to NF EN 60 695-2-10 and 11 ☐

flush vega D: 850°C
surface vega D: 750° C

Compliant with standards:
IEC EN 61439-3 and
NF C 61-910



FD52DN

New vega D, IP30, surface-mounted

- Properties:**
- without door
 - without QuickConnect terminal block, green/yellow
 - with drawing map
 - with DIN rails 24 modules

Description	Number of modules	Height in mm	PU	Order.no.
New vega D distribution 2-row surface-mounted	48	450	1	FD22DN
New vega D distribution 3-row surface-mounted	72	600	1	FD32DN
New vega D distribution 4-row surface-mounted	96	750	1	FD42DN
New vega D distribution 5-row surface-mounted	120	900	1	FD52DN
New vega D distribution 6-row surface-mounted	144	1050	1	FD62DN
New vega D distribution 7-row surface-mounted	168	1200	1	FD72DN



FD52LN

New vega D, IP30, surface-mounted

- Properties:**
- without door
 - with FD00Q1 terminal support to be equipped with QuickConnect

Description	Number of modules	Height in mm	PU	Order.no.
New vega D distribution 2-row surface-mounted	48	450	1	FD22LN
New vega D distribution 3-row surface-mounted	72	600	1	FD32LN
New vega D distribution 4-row surface-mounted	96	750	1	FD42LN
New vega D distribution 5-row surface-mounted	120	900	1	FD52LN
New vega D distribution 6-row surface-mounted	144	1050	1	FD62LN
New vega D distribution 7-row surface-mounted	168	1200	1	FD72LN



FD52GN

New vega D, IP30, surface-mounted, empty, to be equipped

- Properties:**
- without door
 - for the installation of equipment units FD01*, FD02*, FD03*
 - with FD00Q1 terminal base to be equipped with QuickConnect
 - with vertical uprights
 - without DIN rails

Description	Number of modules	Height in mm	PU	Order no.
New vega D to complete 2-row surface-mounted		450	1	FD22GN
New vega D to complete 3-row surface-mounted	24	600	1	FD32GN
New vega D to complete 4-row surface-mounted	48	750	1	FD42GN
New vega D to complete 5-row surface-mounted	72	900	1	FD52GN
New vega D to complete 6-row surface-mounted	96	1050	1	FD62GN
New vega D to complete 7-row surface-mounted	120	1200	1	FD72GN



FU42DN

New Vega D, IP30, flush-mounted

Properties:

- without door
- with overhanging frame 40 mm
- without QuickConnect terminal block, green/yellow
- with drawing map

Description	Number of modules	Height in mm	PU	Order no.
New vega D distribution 2-row flush-mounted	48	537	1	FU22DN
New vega D distribution 3-row flush-mounted	72	687	1	FU32DN
New vega D distribution 4-row flush-mounted	96	837	1	FU42DN
New vega D distribution 5-row flush-mounted	120	987	1	FU52DN
New vega D distribution 6-row flush-mounted	144	1137	1	FU62DN
New vega D distribution 7-row flush-mounted	168	1287	1	FU72DN



FU42LN

New Vega D, IP30, flush-mounted

Properties:

- without door
- with overhanging frame 40 mm
- with FD00Q1 terminal base to be equipped with QuickConnect

Description	Number of modules	Height in mm	PU	Order no.
New vega D distribution 2-row flush-mounted	48	537	1	FU22LN
New vega D distribution 3-row flush-mounted	72	687	1	FU32LN
New vega D distribution 4-row flush-mounted	96	837	1	FU42LN
New vega D distribution 5-row flush-mounted	120	987	1	FU52LN
New vega D distribution 6-row flush-mounted	144	1137	1	FU62LN
New vega D distribution 7-row flush-mounted	168	1287	1	FU72LN



FU42GN

New Vega D, IP30, flush-mounted, empty, to be equipped

Properties:

- without door
- for the installation of equipment units FD01*, FD02*, FD03*
- with overhanging frame 72mm
- with FD00Q1 terminal base to be equipped with QuickConnect
- with vertical uprights

Description	Number of modules	Height in mm	PU	Order no.
New vega D to complete 2-row flush-mounted		537	1	FU22GN
New vega D to complete 3-row flush-mounted	24	687	1	FU32GN
New vega D to complete 4-row flush-mounted	48	837	1	FU42GN
New vega D to complete 5-row flush-mounted	72	987	1	FU52GN
New vega D to complete 6-row flush-mounted	96	1137	1	FU62GN
New vega D to complete 7-row flush-mounted	120	1287	1	FU72GN



FD02A1

Equipment units for modular devices

Properties:

- with labelling field
- with DIN rail(s) for modular devices

Description	Number of modules	Height in mm	PU	Order no.
Kit for 1-row: 1 x 24	24	150	1	FD01A1
Kit for 2-row: 2 x 24	48	300	1	FD02A1
Kit for 1 x DIN rail, 1 x closed	24	300	1	FD02A3



FD02A3



FD02C2

Equipment units for special devices

Properties:

- with perforated metal plate
- depth-adjustable

Description	Number of modules	Height in mm	PU	Order no.
Kit with perf. metal plate		300	1	FD02C2



FD02A2

Equipment units for terminal blocks

Properties:

- with depth-adjustable DIN rails

Description	Number of modules	Height in mm	PU	Order no.
Kit for terminal blocks 1 x 24	24	150	1	FD01A2
Kit for terminal blocks 2 x 24	48	300	1	FD02A2

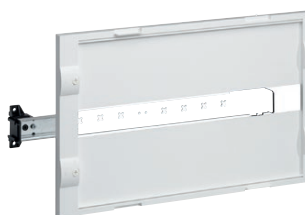

FD02K1

Equipment units for MCCB up to 160A with/without add-on block

Description	Height in mm	PU	Order no.
Kit for MCCB 160A	150	1	FD01K1
Kit for MCCB 160A	300	1	FD02K1
Kit for MCCB 160A	300	1	FD02V2



FD00C3

Covers

Properties:

- Covers for components, top

Description	Height in mm	PU	Order no.
Cover 150x500 slotted		1	FD00C4
Cover 300x500 slotted		1	FD00C1
Cover 300x500 plain + slotted		1	FD00C3
Cover 150x500 plain		1	FD00C5
Cover 300x500 plain		1	FD00C2



Labelling strip

FD00A1

Description	Height in mm	PU	Order no.
Labelling strip 10x		1	FD00A1



Additional DIN rail to fix between 2 modular rows

UZ02B9

Description	Height in mm	PU	Order no.
2 x DIN rail		1	UZ02B9



Blank stripes

JP002

Description	Height in mm	PU	Order no.
Blank stripes		1	JP002



FD52TN



FD52PN

Doors, transparent and closed **IP41 (FDxxxN)** **IP40 (FUxxxN)**

Description	PU	Order no.
Door for Fx22xN, transparent (glass)	1	FD22TN
Door for Fx32xN, transparent (glass)	1	FD32TN
Door for Fx42xN, transparent (glass)	1	FD42TN
Door for Fx52xN, transparent (glass)	1	FD52TN
Door for Fx62xN, transparent (glass)	1	FD62TN
Door for Fx72xN, transparent (glass)	1	FD72TN
Door for Fx22xN, closed	1	FD22PN
Door for Fx32xN, closed	1	FD32PN
Door for Fx42xN, closed	1	FD42PN
Door for Fx52xN, closed	1	FD52PN
Door for Fx62xN, closed	1	FD62PN
Door for Fx72xN, closed	1	FD72PN



FD00S5

FD00S1

Closing systems

Description	PU	Order no.
Standard closing system	1	FD00S0
With key lock 1242E	1	FD00S1
With key lock triangle 7 mm	1	FD00S2
With key lock square 7 mm	1	FD00S3
With key lock 405	1	FD00S4
With key lock two-way 3 mm	1	FD00S5



FD00Q1

Terminal bases

Description	PU	Order no.
Terminal base for QuickConnect terminal KN...	1	FD00Q1
Terminal base for brass terminals K...	1	FD00Q2



FD00P2



FD00P3

Cable flanges

Description	PU	Order no.
Cable entry slider rectangular (as spare part)	1	FD00P1
Cable entry slider with 2 x flange VZ741	1	FD00P2
Cable entry slider with round knockouts	1	FD00P3
Rear cable entry flange	1	VZ741



FD00E1

Adapter for surface enclosures

Description	PU	Order no.
Adapter for systo devices	1	FD00E1



WS032

Built-in switches and socket outlets

Properties:
- to mount into FD00E1

Description	PU	Order no.
Adapter for systo devices	1	FD00E1
systo socket outlet earth pin	1	WS100
systo socket outlet earth pin	1	WS101
systo Schuko socket outlet	1	WS160
Hinged cover for 1gang socket outlet	1	WS179
systo intermediate switch	1	WS010
systo emergency stop key switch	1	WS032
systo key switch 2 pos.	1	WS035
systo LED pilot lamp green/red	1	WS601
systo RJ45 Cat6 UTP	1	WS219
systo HDMI	1	WS264
systo USB	1	WS265



FD00P4

Side cable entry plates

Description	VPE	Best.Nr.
Kit with 2 side plates up to M40	1	FD00P4
Kit with 2 aeration grids	1	FD00P5



FD00F1

Enclosure mounting accessories for surface-mounted enclosures

Description	PU	Order no.
Enclosure association kit	1	FD00F1
External mounting brackets kit, vertical/horizontal	1	FD00F2



FD00F2

Enclosure mounting accessories for flush enclosures



VZ405N

Description	PU	Order no.
Hollow wall set (4x)	1	VZ405N



Cable guide accessories

Description	PU	Order no.
Cable clamp, large	20	UZ25V1
Cable clamp, small	20	UZ25V2
Kit with surface-mounted and brackets (as spare parts)	10	FD00B1
Kit with flush-mounted cable holder	10	FD00B2
Adapter for UZ25V1 oder UZ25V2	20	UZ01V1
Cable strain relief bar (delivered-by in FDxDN)	1	FD00F3



FD00F3



FD00T1

Trunking horizontal

Properties:

- 4 pieces 44 cm each
- fixation without tool
- for surface and flush 72 mm

Description	PU	Order no.
4x trunking standard HxW 80x30 mm, RAL 7030	1	FD00T1
4x trunking halogen-free HxW 80x30 mm, RAL 7035	1	FD00T2

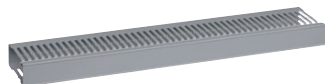

BA7A60030

Trunking vertical, for surface enclosure only

Properties:

- 2 m length, 30 cm width
- can be mounted horizontally in surface and flush
- fixation without tool

Description	PU	Order no.
Trunking HxW 40x30mm, for all enclosures	1	BA7A40030
Trunking HxW 60x30mm, for all enclosures	1	BA7A60030
Trunking HxW 80x30mm, for surface and flush 72mm only	1	BA7A80030
Trunking HxW 100x30mm, for surface and flush 72 mm only	1	BA7A100030
Trunking halogen-free HxW 40x30 mm, for all enclosures	1	HA740030
Trunking halogen-free HxW 60x30 mm, for all enclosures	1	HA760030
Trunking halogen-free HxW 80x30 mm, for surface and flush 72mm only	1	HA780030
Trunking halogen-free HxW 100x30 mm, for surface and flush 72mm only	1	HA7100030



BA70402

Cover

Properties:

- for surface-mounted cabinets
- for clipping onto cable holders FD00B1

Description	PU	Order no.
Cover standard 2 m length, RAL 7030	1	BA70302
Cover halogen-free 2 m length, RAL 7035	1	HA70302

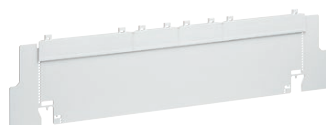

FD00A3

Partitions horizontal

Description	PU	Order no.
Partition horizontal for surface	1	FD00A3
Partition horizontal for flush 72 mm	1	FD00A4
Partition horizontal for flush 40 mm	1	FD00A5



FD00H1

Supports for DIN rails

Description	PU	Order no.
Base support 2x	1	FD00H1
DIN rail support 2x (for surface and flush 72 mm only)	1	FD00H2

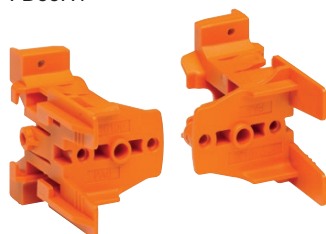

FD00H2

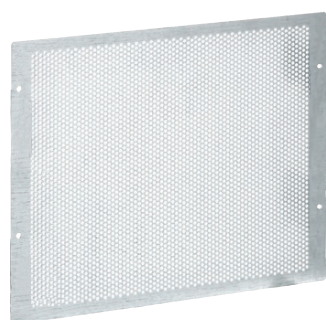

FD00M1

Mounting plates

Description	PU	Order no.
Perforated plate 225x440	1	FD00M1
Mounting plate 300x440		FD00M2
Perforated plate 150x440		FD00M3
Mounting plate 150x440	1	FD00M4

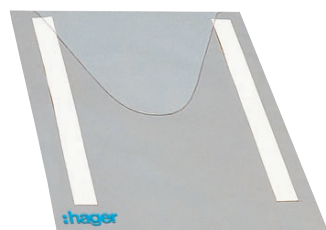

FZ794

Drawing map

Description	PU	Order no.
Drawing map, transparent, A4	1	FZ794

Surface-mounted, IP30, IP41

Flush-mounted IP30, IP40

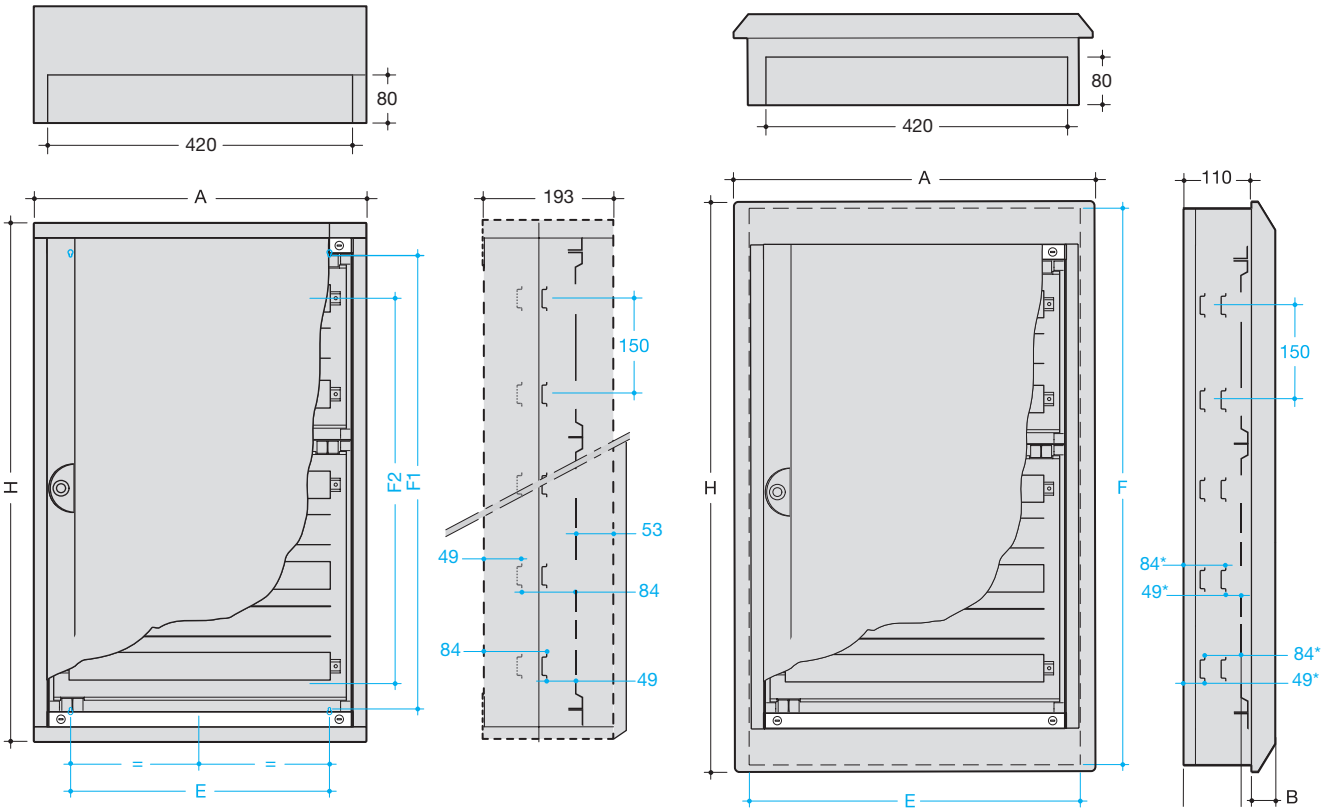

* version FUx2GN only

Dimensions

Surface-mounted enclosures

Order numbers		Dimensions of enclosure		Fixing		
		A	H	E	F1	F2
FD22GN	FD22DN/LN	550	450	350	325	245
FD32GN	FD32DN/LN	550	600	350	475	395
FD42GN	FD42DN/LN	550	750	350	625	545
FD52GN	FD52DN/LN	550	900	350	775	695
FD62GN	FD62DN/LN	550	1050	350	925	845
FD72GN	FD72DN/LN	550	1200	350	1075	995

Flush-mounted enclosures

Order numbers	Dimensions of frame			Wall niche	
	A	H	B	E	F
FU22DN/LN	600	537	40	550	506
FU32DN/LN	600	687	40	550	656
FU42DN/LN	600	837	40	550	806
FU52DN/LN	600	987	40	550	956
FU62DN/LN	600	1137	40	550	1106
FU72DN/LN	600	1287	40	550	1256
FU22GN	600	537	72	550	506
FU32GN	600	687	72	550	656
FU42GN	600	837	72	550	806
FU52GN	600	987	72	550	956
FU62GN	600	1137	72	550	1106
FU72GN	600	1287	72	550	1256

**Hager Group**

Zum Gunterstal
66440 Blieskastel
Germany

132, boulevard d'Europe
67215 Obernai
France

Tel: +33 (0)3 88 49 50 50

Hager Middle East FZE

Laboratory Complex Bldg.
Office N° 219
Dubai Science Park
Al Barsha South 2
P.O. Box N° 61056, Dubai
United Arab Emirates

Tel: +(971) 4 5105300
Fax: +(971) 4 4251598

Hager Electro B.V.

Building N°01, Office N° 24
Al-Bayt Bldg. King Abdul Aziz Street
P.O. Box N° 4280, Riyadh
Kingdom of Saudi Arabia

Tel: +(966) 11 292 4541
Fax: +(966) 11 292 3744

Hager Electro B.V.

Building N° 840, Office N°7
Concord Business Center
Al Rawabi Street, C Ring Road
P.O. Box N° 31830, Doha
Qatar

Tel: +(974) 4032 6447
Fax: +(974) 4441 8707

hager-me.com